



# Prius

## Bumper Corner Protector Installation instructions

Model year:	01/2012
Vehicle code:	ZVW30*-AHXEBW
Part number:	PZ415-G0521-00
 Weight:	0.18 kg
Manual reference number:	AIM 002 422-0

# Revision Record

Rev. No	Date	Page	Picture	Update	New	Deleted Steps

# Compatibility Record

Toyota Parking Aid sensors = OK

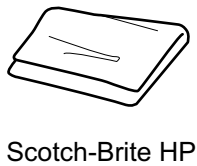
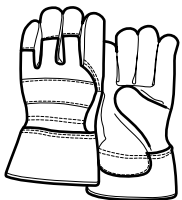
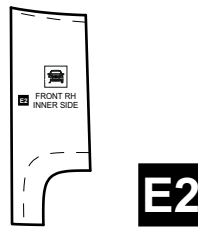
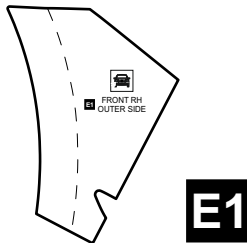
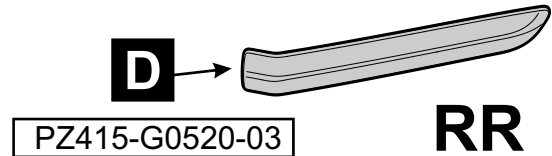
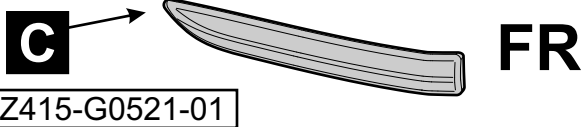
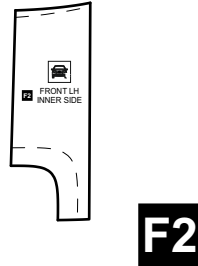
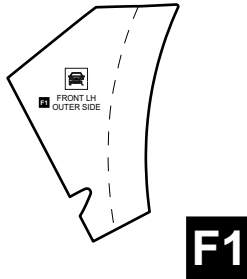
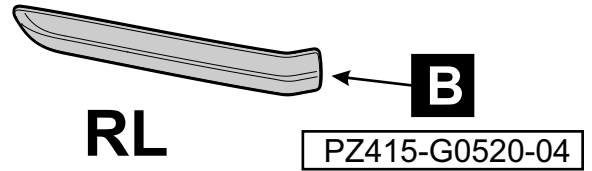
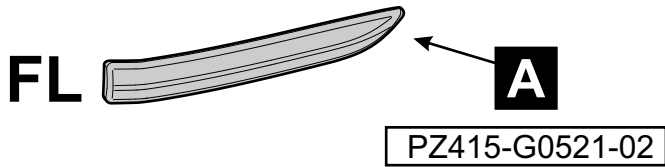

Cleaner



Sikkens M600  
 Spiess Hecker 7799  
 Panel Degreaser PZ469-CL001-50  
 alternative

50/50 mix of isopropyl alcohol and water

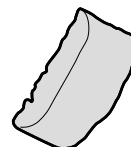
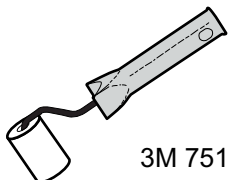
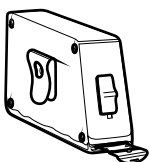
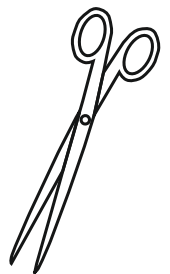

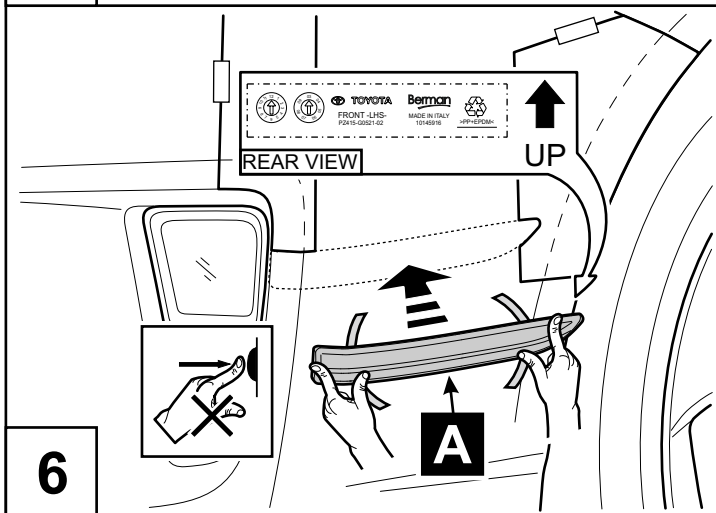
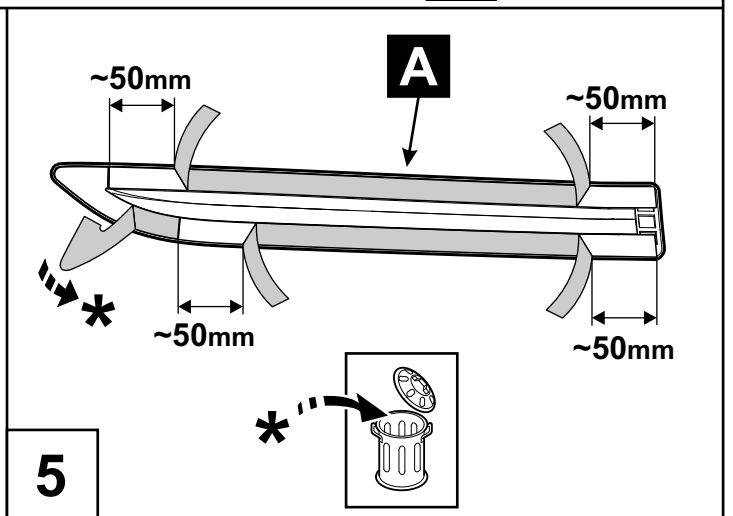
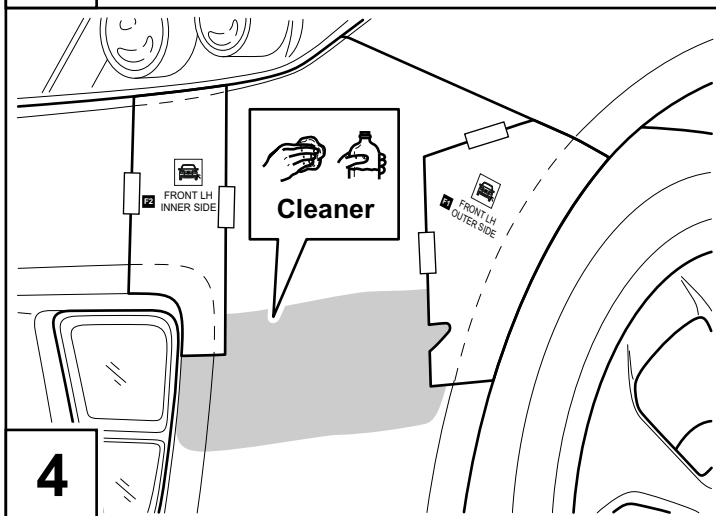
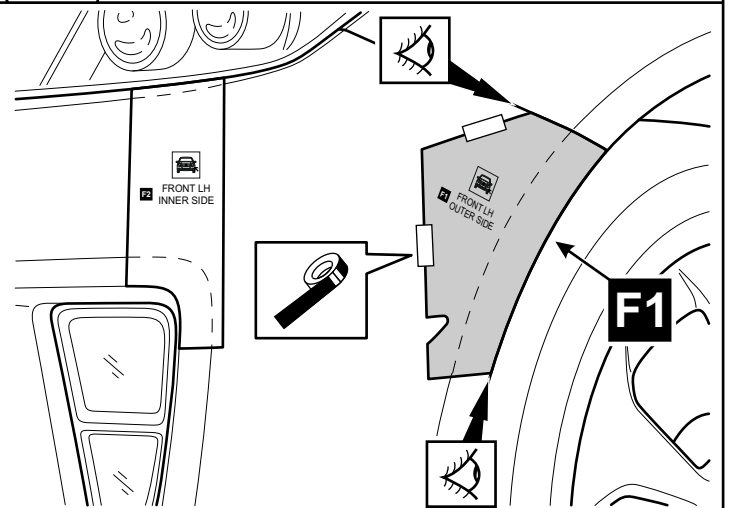
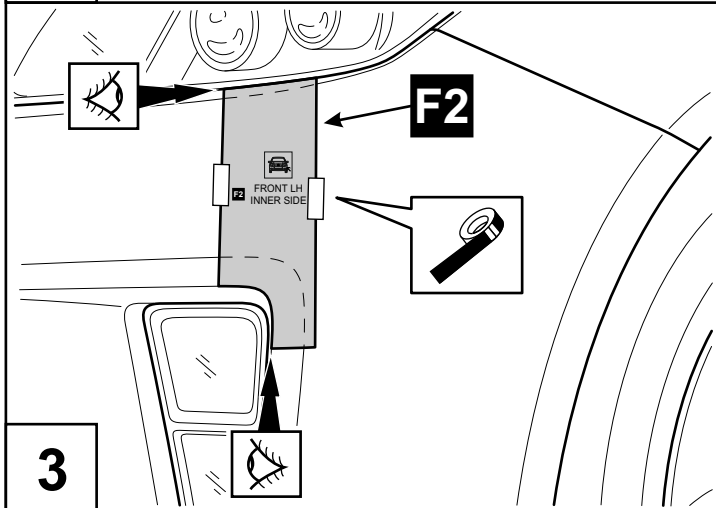
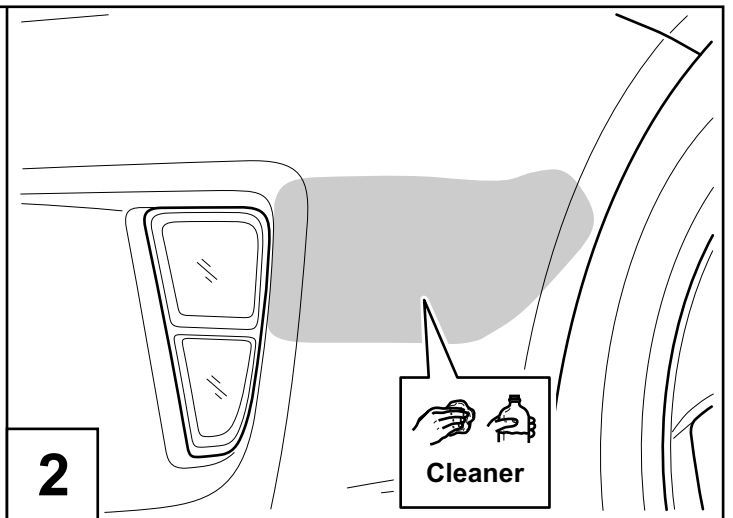
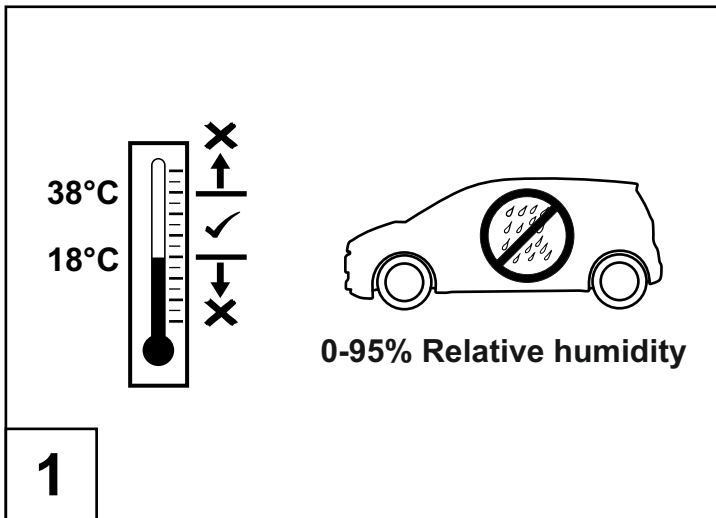

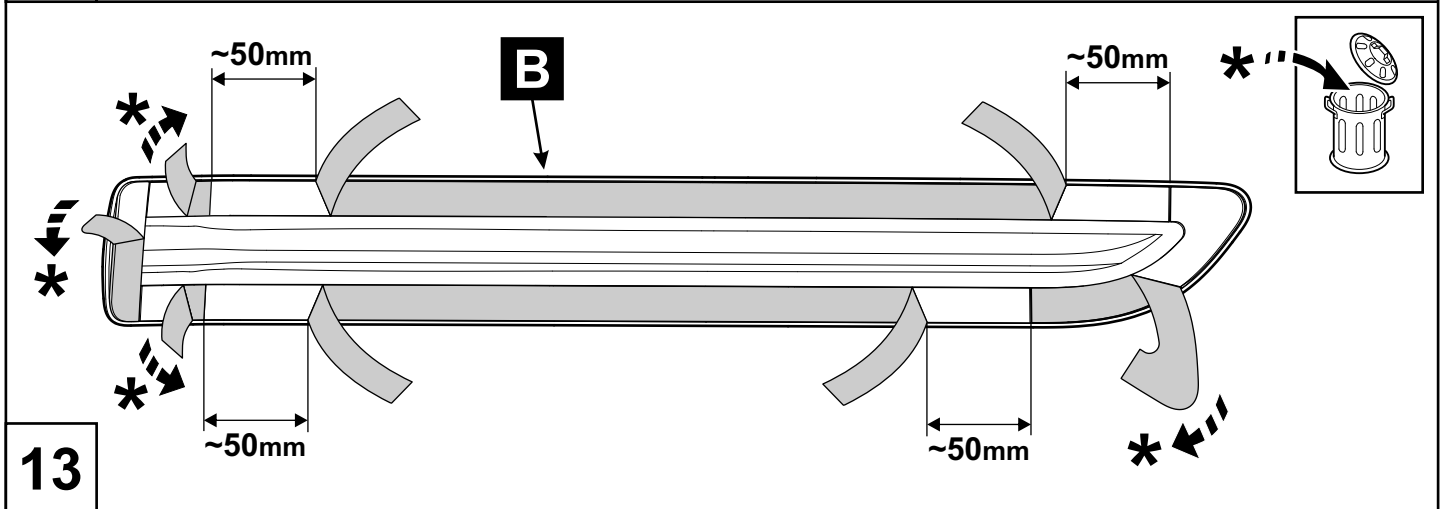
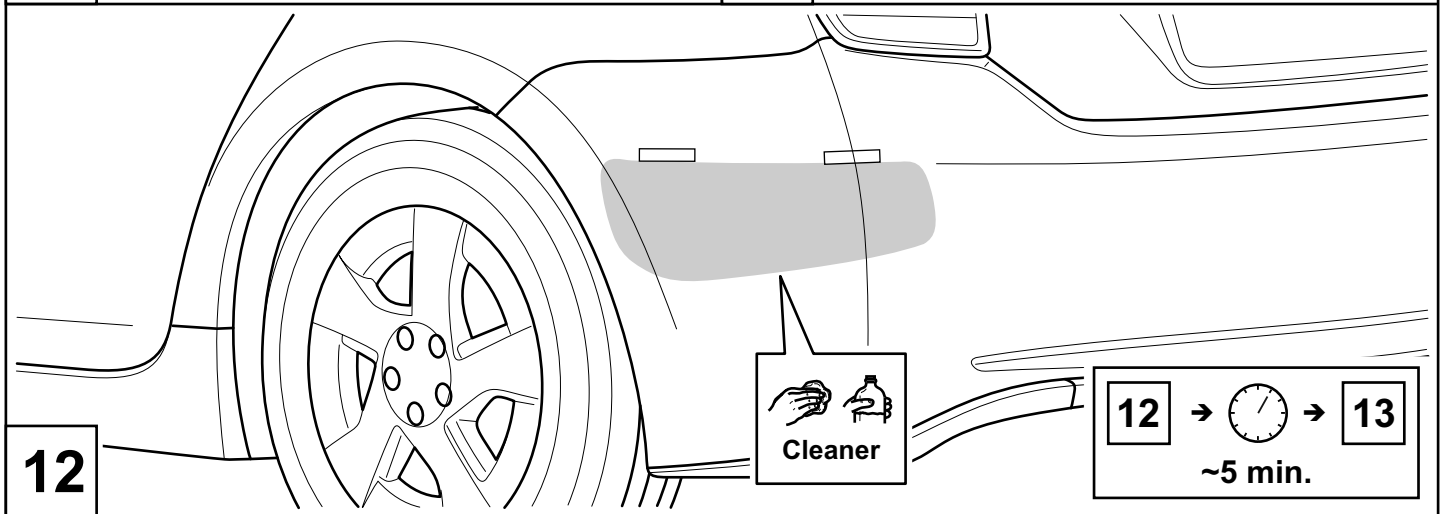
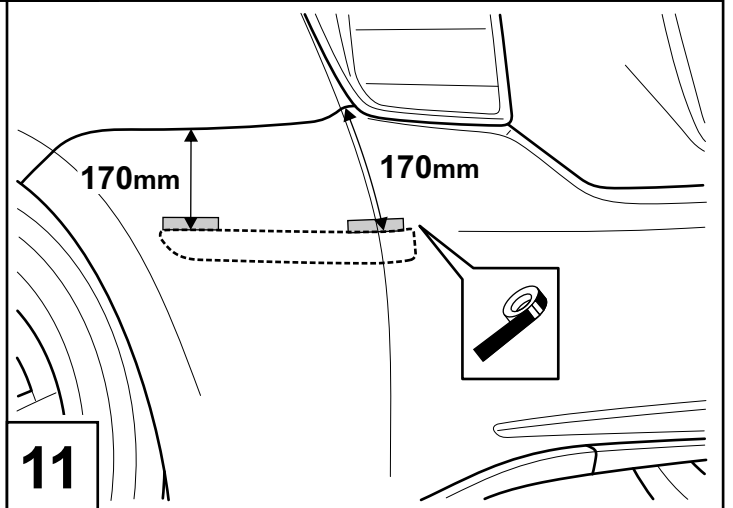
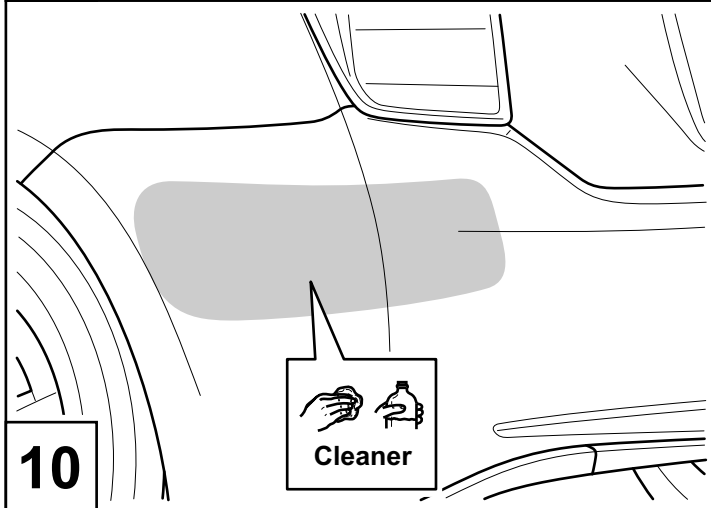
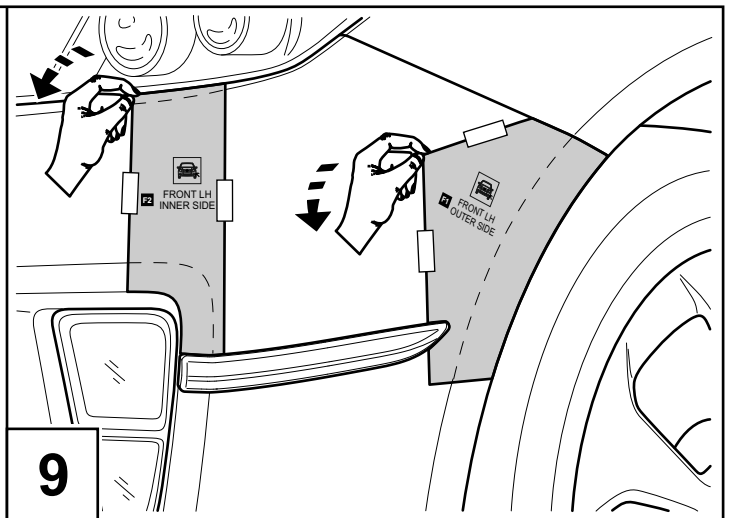
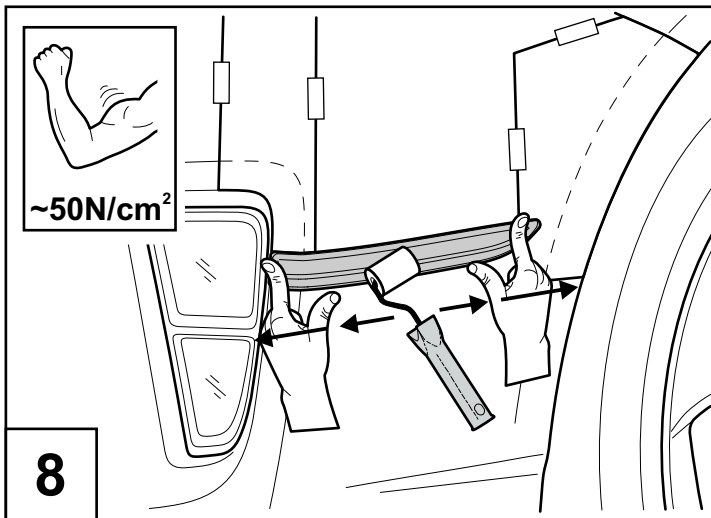

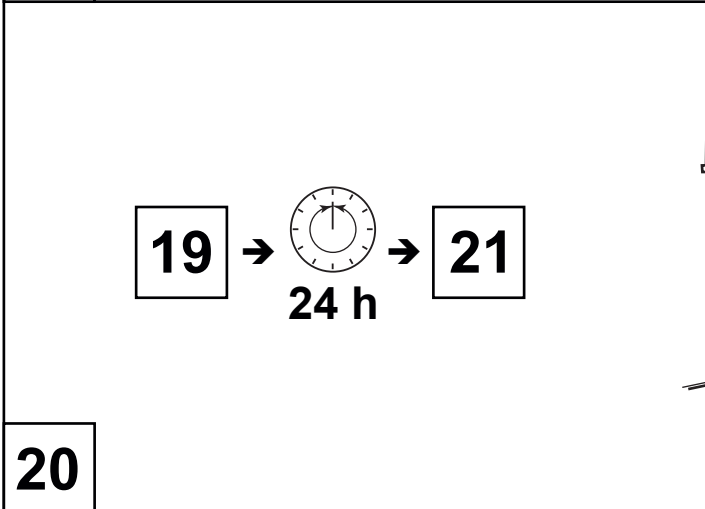
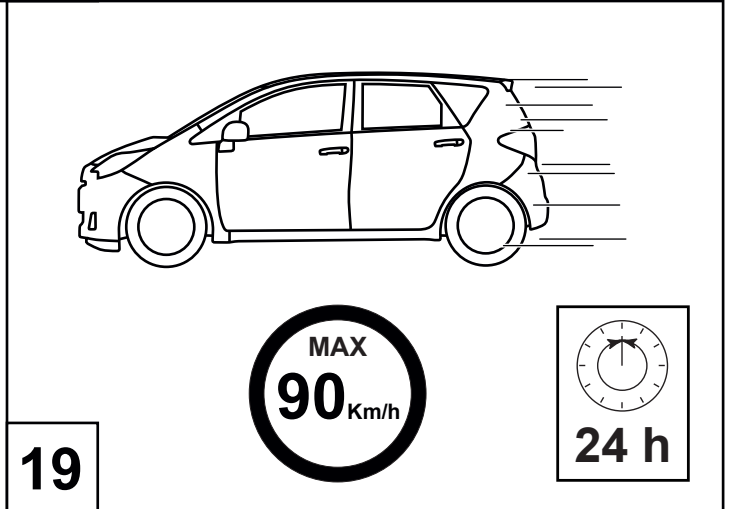
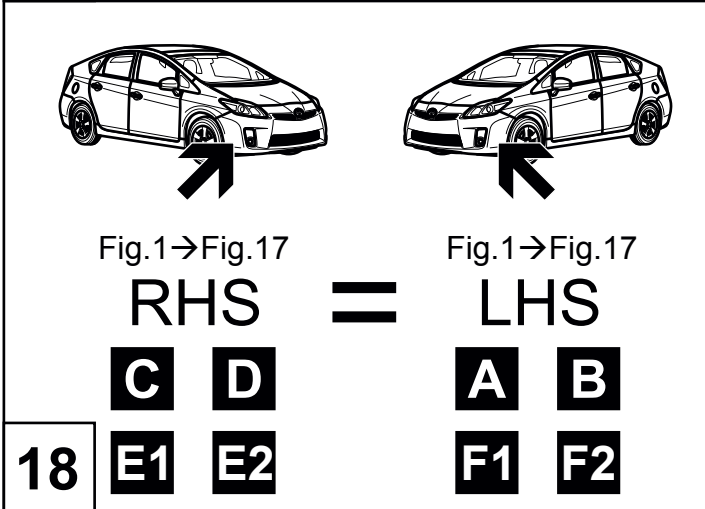
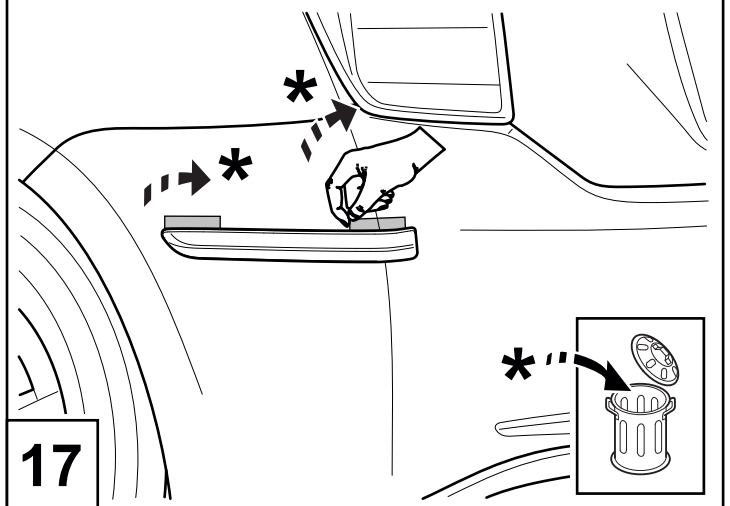
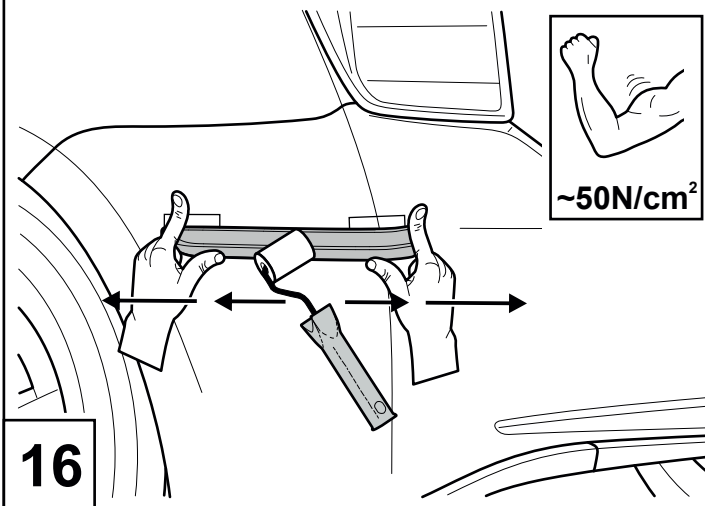
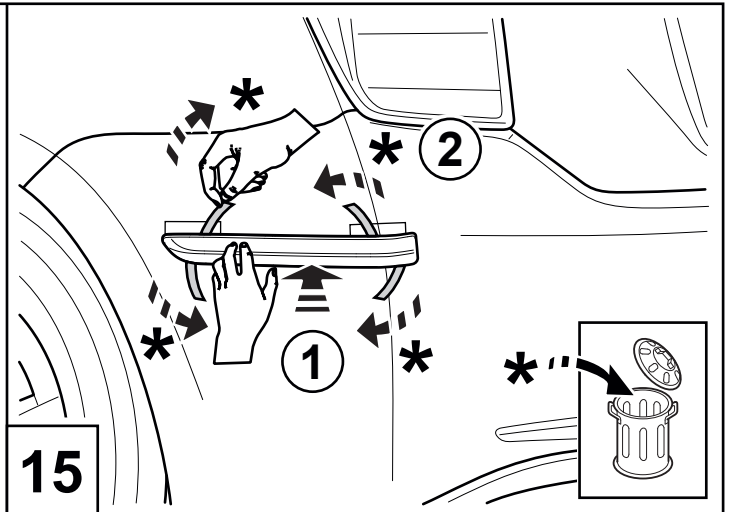
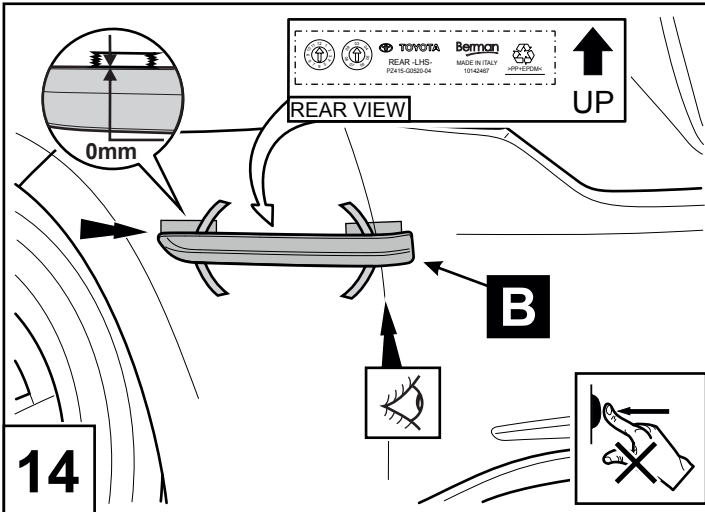



RHS = LHS

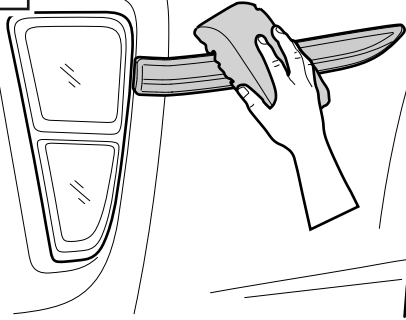

21

RHS = LHS

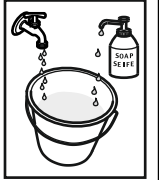
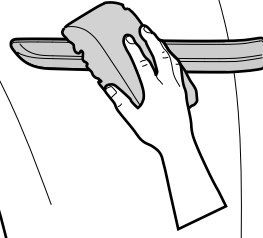

## PAINTING INSTRUCTION PP TEXTURED PARTS

1. Bake for 60 min at 70 °C.
2. Clean several times with plenty of fresh **Standoflex Thinner 11100** and an ultra fine pad.
3. Wet sand-papering (Scotch Brite: grey or red).
4. Reclean with **Standoflex Thinner 11100**.
5. Allow to dry completely.
6. Apply one coat of **Standoflex Plastic Primer Silver**.
7. Flash off.
8. Apply **2K HS Repair Filler** with 15% **2K Plastic Additive** together with **2K HS Hardener 3945**.  
Apply two coats to completely remove the structure.
9. Bake for 45 min at 60 °C.
10. Dry sand paper with P400.
11. Apply **Standohyd Basecoat**.
12. Flash off.
13. Apply **2K HS Clear** with 10% **2K Plastic Additive** together with **2K HS Hardener 3945**.
14. Bake for 45 min at 60 °C.

## LACKIERANWEISUNGEN FÜR STRUKTURIERTE PP-TEILE

1. 60 Min. bei 70 °C einbrennen.
2. Mehrere Male mit reichlich frischem **Standoflex Verdünner 11100** und einem ultrafeinen Pad reinigen.
3. Nass schleifen (Scotch Brite: grau oder rot).
4. Erneut mit **Standoflex Verdünner 11100** reinigen.
5. Vollständig trocknen lassen.
6. Eine Schicht **Standoflex Kunststoff-Primer Silver** auftragen.
7. Ablüften lassen.
8. **2K HS Reparaturspachtel** mit 15% **2K Kunststoffzusatz** zusammen mit **2K HS Härter 3945** auftragen.  
Zwei Schichten auftragen, sodass die Strukturierung vollständig verschwunden ist.
9. 45 Min. bei 60 °C einbrennen.
10. Mit Körnung P400 schleifen.
11. **Standohyd Grundlack** auftragen.
12. Ablüften lassen.
13. **2K HS Klarlack** mit 10% **2K Kunststoffzusatz** zusammen mit **2K HS Härter 3945** auftragen.
14. 45 Min. bei 60 °C einbrennen.

## INSTRUCTIONS DE PEINTURE DES PARTIES TEXTUREES PP

1. Cuire à 70 °C pendant 60 min.
2. Nettoyer plusieurs fois en utilisant abondamment du **Standoflex Thinner 11100** neuf et un tampon ultrafin.
3. Poncer à l'eau (Scotch Brite: gris ou rouge).
4. Nettoyer à nouveau avec du **Standoflex Thinner 11100**.
5. Laisser complètement sécher.
6. Appliquer une couche de **Standoflex Plastic Primer Silver**.
7. Sécher superficiellement.
8. Appliquer du **2K HS Repair Filler** avec 15% de **2K Plastic Additive** conjointement avec du **2K HS Hardener 3945**.  
Appliquer deux couches pour éliminer totalement la structure.
9. Cuire à 60 °C pendant 45 min.
10. Poncer à sec avec du P400.
11. Appliquer du **Standohyd Basecoat**.
12. Sécher superficiellement.
13. Appliquer du **2K HS Clear** avec 10% de **2K Plastic Additive** conjointement avec du **2K HS Hardener 3945**.
14. Cuire à 60 °C pendant 45 min.

## ISTRUZIONI DI VERNICIATURA PARTI GRANULATE PP

1. Cuocere per 60 minuti a 70 °C.
2. Pulire parecchie volte con abbondante **Standoflex Thinner 11100** e un tampone abrasivo ultrafine.
3. Cartavetrare a umido (Scotch Brite: grigio o rosso).
4. Ripulire con **Standoflex Thinner 11100**.
5. Permettere che si essichi completamente.
6. Applicare una mano di **Standoflex Plastic Primer Silver**.
7. Lasciar asciugare finché diventa opaco.
8. Applicare **2K HS Repair Filler** con **2K Plastic Additive** al 15% insieme a **2K HS Hardener 3945**.  
Applicare due mani per rimuovere completamente la struttura.
9. Cuocere per 45 minuti a 60 °C.
10. Cartavetrare a secco con P400.
11. Applicare **Standohyd Basecoat**.
12. Lasciar asciugare finché diventa opaco.
13. Applicare **2K HS Clear** con **2K Plastic Additive** al 10% insieme a **2K HS Hardener 3945**.
14. Cuocere per 45 minuti a 60 °C.



## INSTRUCCIONES PARA LA PINTURA DE PIEZAS CON TEXTURA PP

1. Caliente durante 60 minutos a 70 °C.
2. Limpie varias veces con abundante **Standoflex Thinner 11100** fresco y una almohadilla ultrafina.
3. Lijado húmedo (Scotch Brite: gris o rojo).
4. Vuelva a limpiar con **Standoflex Thinner 11100**.
5. Deje secar completamente.
6. Aplique una capa de **Standoflex Plastic Primer Silver**.
7. Vaporice.
8. Aplique **2K HS Repair Filler** con un 15% de **2K Plastic Additive** junto con **2K HS Hardener 3945**.  
Aplique dos capas para quitar toda la estructura.
9. Caliente durante 45 minutos a 60 °C.
10. Lije en seco con P400.
11. Aplique **Standohyd Basecoat**.
12. Vaporice.
13. Aplique **2K HS Clear** con un 10% de **2K Plastic Additive** junto con **2K HS Hardener 3945**.
14. Caliente durante 45 minutos a 60 °C.

## INSTRUÇÕES PARA PINTAR PEÇAS TEXTURIZADAS DE PP

1. Cozer durante 60 minutos a 70 °C.
2. Limpar várias vezes com bastante **Standoflex Thinner 11100** e uma almofada ultra-fina.
3. Humedecer a lixa (Scotch Brite: cinzento ou vermelho).
4. Voltar a limpar com **Standoflex Thinner 11100**.
5. Deixar secar completamente.
6. Aplicar uma camada de **Standoflex Plastic Primer Silver**.
7. Retirar o brilho.
8. Aplicar **2K HS Repair Filler** com 15% de **2K Plastic Additive** juntamente com **2K HS Hardener 3945**.  
Aplicar duas camadas para remover completamente a estrutura.
9. Cozer durante 45 minutos a 60 °C.
10. Utilizar uma lixa seca com P400.
11. Aplicar **Standohyd Basecoat**.
12. Retirar o brilho.
13. Aplicar **2K HS Clear** com 10% de **2K Plastic Additive** juntamente com **2K HS Hardener 3945**.
14. Cozer durante 45 minutos a 60 °C.

## RICHTLIJNEN VOOR HET SCHILDEREN VAN PP TEXTUURDELEN

1. Gedurende 60 min bakken op 70 °C.
2. Verschillende malen reinigen met zuivere **Standoflex Thinner 11100** en een extra fijne spons.
3. Gebruik nat schuurpapier (Scotch Brite: grijs of rood).
4. Opnieuw reinigen met **Standoflex Thinner 11100**.
5. Laat volledig drogen.
6. Breng een laag **Standoflex Plastic Primer Silver** aan.
7. Licht afschuren.
8. Breng **2K HS Repair Filler** aan met 15% **2K Plastic Additive** samen met **2K HS Hardener 3945**.  
Breng twee lagen aan om de structuur volledig te doen verdwijnen.
9. Bak gedurende 45 min op 60 °C.
10. Gebruik droog schuurpapier P400.
11. Breng een **Standohyd Basecoat** aan.
12. Licht afschuren.
13. Breng **2K HS Clear** aan met 10% **2K Plastic Additive** samen met **2K HS Hardener 3945**.
14. Bak gedurende 45 min op 60 °C.

## MALEVEJLEDNING PP-EFFEKTDLELE

1. Bag i 60 min. ved 70 °C.
2. Rengør flere gange med rigeligt frisk **Standoflex Thinner 11100** (fortynder) og en meget fin svamp.
3. Lav våd slibning med sandpapir (Scotch Brite: grå eller rød).
4. Gør ren igen med **Standoflex Thinner 11100** (fortynder).
5. Lad den tørre helt.
6. Påfør et lag **Standoflex Plastic Primer Silver** (grunder).
7. Lad det fordampe.
8. Påfør **2K HS Repair Filler** (spartelmasse) med 15% **2K Plastic Additive** (plasttilsætning) sammen med **2K HS Hardener 3945** (hærdemiddel) Påfør to lag mere for helt at fjerne strukturen.
9. Bag i 45 min. ved 60 °C.
10. Slib med tørt sandpapir P400.
11. Påfør **Standohyd Basecoat** (underlag).
12. Lad det fordampe.
13. Påfør **2K HS Clear** (klar) med 10% **2K Plastic Additive** (plasttilsætning) sammen med **2K HS Hardener 3945** (hærdemiddel).
14. Bag i 45 min. ved 60 °C.

## LACKERINGSANVISNING, PP-DELAR MED STRUKTURERAD YTA

1. Värm i 60 min och 70 °C.
2. Rengör upprepade gånger med flödigt av färsk **Standoflex Thinner 11100** och en mycket fin dyna.
3. Våtslipa (Scotch Brite: grå eller röd).
4. Rengör igen med **Standoflex Thinner 11100**.
5. Låt torka fullständigt.
6. Applicera ett lager av **Standoflex Plastic Primer Silver**.
7. Låt torka.
8. Applicera **2K HS Repair Filler** med 15% **2K Plastic Additive** blandat med **2K HS Hardener 3945**. Applicera två lager för att jämna ut ytan helt.
9. Härda i 45 min och 60 °C.
10. Slipa med torrt sandpapper P400.
11. Applicera **Standohyd Basecoat**.
12. Låt torka.
13. Applicera **2K HS Clear** med 10% **2K Plastic Additive** blandat med **2K HS Hardener 3945**.
14. Härda i 45 min och 60 °C.

## MAALAUOHJE, PP-KUVIOIDUT OSAT

1. Paista 70 °C:ssa 60 minuuttia.
2. Puhdista useita kertoja käyttämällä runsaasti puhdasta **Standoflex Thinner 11100** -ohennetta ja erityishienoa tyynyä.
3. Hio märkähiomapaperilla (harmaa tai punainen Scotch-Brite).
4. Puhdista uudelleen **Standoflex Thinner 11100** -ohenteella.
5. Anna kuivua täysin.
6. Levitä yksi kerros **Standoflex Plastic Primer Silver** -pohjamaalia.
7. Anna haihtua.
8. Levitä **2K HS Repair Filler** -täyteainetta, jossa on 15 % **2K Plastic Additive** -lisäainetta, ja **2K HS Hardener 3945** -kovetinta. Levitä kaksi kerrosta, jotta kuvioinnin rakenne poistuu täysin.
9. Paista 60 °C:ssa 45 minuuttia.
10. Hio tavallisella P400-hiomapaperilla.
11. Levitä **Standohyd Basecoat** -pohjustus.
12. Anna haihtua.
13. Levitä **2K HS Clearia**, jossa on 10% **2K Plastic Additive** -lisäainetta, ja **2K HS Hardener 3945** -kovetinta.
14. Paista 60 °C:ssa 45 minuuttia.

## MALERINSTRUKSER FOR DELER MED PP-STRUKTUR

1. Ovnstørk i 60 minutter ved 70 °C.
2. Rengjør gjentatte ganger med store mengder ren tynner av typen **Standoflex Thinner 11100** og en ultrafin sudd.
3. Bruk vått sandpapir (Scotch Brite: grått eller rødt).
4. Rengjør på nytt med **Standoflex Thinner 11100**.
5. La stå og tørke til helt tørt.
6. Påfør ett lag med grunning av typen **Standoflex Plastic Primer Silver**.
7. Jevn ut.
8. Påfør **2K HS Repair Filler** med 15% **2K Plastic Additive** sammen med herder av typen **2K HS Hardener 3945**. Påfør to lag, slik at all struktur jevnes ut.
9. Ovnstørk i 45 minutter ved 60 °C.
10. Puss med tørt sandpapir av typen P400.
11. Påfør **Standohyd Basecoat**.
12. Jevn ut.
13. Påfør **2K HS Clear** med 10% **2K Plastic Additive** sammen med herder av typen **2K HS Hardener 3945**.
14. Ovnstørk i 45 minutter ved 60 °C.

## POKYNY K LAKOVÁNÍ DÍLŮ Z PP S TEXTUROU

1. Pečte po dobu 60 min při teplotě 70 °C.
2. Několikrát vyčistěte dostatečným množstvím čerstvého ředidla **Standoflex 11100** a velice jemným hadříkem.
3. Za mokra povrch obracejte (Scotch Brite: šedý nebo červený).
4. Znovu vyčistěte ředidlem **Standoflex 11100**.
5. Nechejte povrch důkladně vyschnout.
6. Naneste jednu vrstvu laku **Standoflex Plastic Primer Silver**.
7. Odvětrejte.
8. Naneste **2složkový servisní tmel HS** s 15% **2složkovou přísadou na plasty** společně s **2složkovou tvrdicí přísadou HS 3945**. Naneste dvě vrstvy tak, aby struktura zcela zmizela.
9. Pečte po dobu 45 min při teplotě 60 °C.
10. Za sucha povrch obracejte pomocí P400.
11. Naneste **základní nátěr Standohyd**.
12. Odvětrejte.
13. Naneste **2složkový průhledný lak HS** s 10% **2složkovou přísadou na plasty** společně s **2složkovou tvrdicí přísadou HS 3945**.
14. Pečte po dobu 45 min při teplotě 60 °C.

## INSTRUKCJA LAKIEROWANIA FRAKTUROWANYCH CZĘŚCI Z POLIPROPYLENU

1. Wypalać przez 60 min w temp. 70 °C.
2. Oczyszczyć kilkakrotnie za pomocą dużej ilości świeżego rozcieńczalnika **Standoflex Thinner 11100** i delikatnej drobnowłóknistej szmatki.
3. Zmatować na mokro papierem ściernym (Scotch Brite: szary lub czerwony).
4. Ponownie oczyścić za pomocą **Standoflex Thinner 11100**.
5. Odczekać, aż do całkowitego wyschnięcia.
6. Nanieść jedną warstwę podkładu **Standoflex Plastic Primer Silver**.
7. Odczekać, aż zwiąże.
8. Nanieść szpachlówkę 2-składnikową **2K HS Repair Filler** z 15% 2-składnikowym plastyfikatorem **2K Plastic Additive** razem z 2-składnikowym utwardzaczem **2K HS Hardener 3945**. Nanieść dwie warstwy, aby całkowicie usunąć strukturę.
9. Wypalać przez 45 min w temp. 60 °C.
10. Zmatować na sucho papierem ściernym o ziarnistości P400.
11. Nanieść podkład **Standohyd Basecoat**.
12. Odczekać, aż zwiąże.
13. Nanieść 2-składnikowy lakier bezbarwny **2K HS Clear** z 10% 2-składnikowym plastyfikatorem **2K Plastic Additive** razem z 2-składnikowym utwardzaczem **2K HS Hardener 3945**.
14. Wypalać przez 45 min w temp. 60 °C.

## ИНСТРУКЦИЯ ПО ОКРАСКЕ ТЕКСТУРИРОВАННЫХ ПОЛИПРОПИЛЕНОВЫХ ДЕТАЛЕЙ

1. Сушить 60 мин при 70 °C.
2. Очистить несколько раз большим количеством свежего разбавителя **Standoflex Thinner 11100** с помощью сверхтонкой губки.
3. Мокрое ошкуривание (Scotch Brite: серая или красная).
4. Повторно очистить разбавителем **Standoflex Thinner 11100**.
5. Дать полностью просохнуть.
6. Нанести один слой грунтовки для пластмассы **Standoflex Plastic Primer Silver**.
7. Дать подсохнуть.
8. Нанести ремонтный порозаполнитель **2K HS Repair Filler** с 15% присадки для пластмассы **2K Plastic Additive** вместе с отвердителем **2K HS Hardener 3945**. Для полного скрытия структуры нанести два слоя.
9. Сушить 45 мин при 60 °C.
10. Сухое ошкуривание шкуркой P400.
11. Нанести базовую краску **Standohyd Basecoat**.
12. Дать подсохнуть.
13. Нанести прозрачный лак **2K HS Clear** с 10% присадки для пластмассы **2K Plastic Additive** вместе с отвердителем **2K HS Hardener 3945**.
14. Сушить 45 мин при 60 °C.

## ΟΔΗΓΙΑ ΒΑΦΗΣ ΤΜΗΜΑΤΩΝ ΥΦΗΣ ΠΟΛΥΠΡΟΠΥΛΕΝΙΟΥ

1. Τοποθέτηση στο φούρνο επί 60 λεπτά στους 70 °C.
2. Καθαρισμός αρκετές φορές με άφθονη ποσότητα φρέσκου διαλυτικού **Standoflex Thinner 11100** και εξαιρετικά λεπτόκοκο γυαλόχαρτο.
3. Υγρή εκτριβή με γυαλόχαρτο (Scotch Brite: γκρί ή κόκκινο).
4. Εκ νέου καθαρισμός με διαλυτικό **Standoflex Thinner 11100**.
5. Αφήστε το στεγνώσει εντελώς.
6. Εφαρμογή μίας στρώσης **Standoflex Plastic Primer Silver**.
7. Εξαέρωση.
8. Εφαρμογή **2K HS Repair Filler** με 15% **2K Plastic Additive** μαζί με **2K HS Hardener 3945**. Εφαρμογή δύο στρώσεων για να αφαιρεθεί εντελώς το υπόστρωμα.
9. Τοποθέτηση στο φούρνο επί 45 λεπτά στους 60 °C.
10. Ξηρή εκτριβή με γυαλόχαρτο P400.
11. Εφαρμογή **Standohyd Basecoat**.
12. Εξαέρωση.
13. Εφαρμογή **2K HS Clear** με 10% **2K Plastic Additive** μαζί με **2K HS Hardener 3945**.
14. Τοποθέτηση στο φούρνο επί 45 λεπτά στους 60 °C.

## BOYA TALİMATI PP DOKULU PARÇALAR

1. 70°C'de 60 dak. fırınlayın.
2. Bir kaç kez bol miktarda taze **Standoflex Tiner 11100** ve ultra ince bir ped ile temizleyin.
3. Islak zımparalama (Scotch Brite: gri veya kırmızı).
4. **Standoflex Tiner 11100** ile tekrar temizleyin.
5. Tamamen kurumaya bırakın.
6. Bir kat **Standoflex Plastik Primer Silver** sürün.
7. Kurutun.
8. %15 **2K Plastik Katkı Maddesi** ve **2K HS Sertleştirici 3945** ile **2K HS Onarım Dolgusu** sürün. Yapıyı tamamen çıkartmak için iki kat sürün.
9. 60°C'de 45 dak. fırınlayın.
10. P400 ile kuru zımparalama.
11. **Standohyd Astar** sürün.
12. Kurutun.
13. %10 **2K Plastik Katkı Maddesi** ve **2K HS Sertleştirici 3945** ile **2K HS Saydam** sürün.
14. 60°C'de 45 dak. fırınlayın.

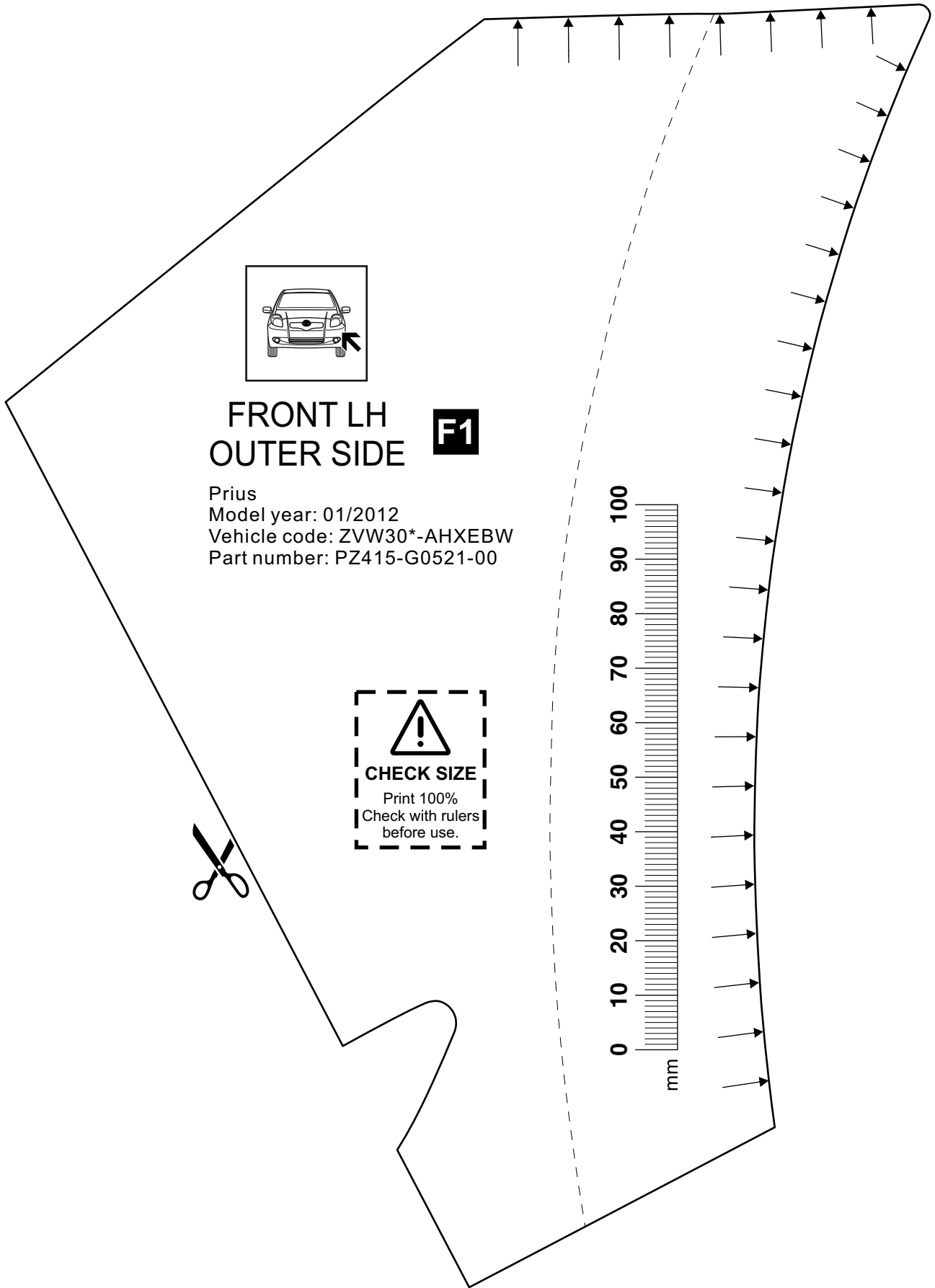

**FRONT LH  
OUTER SIDE** **F1**

Prius  
Model year: 01/2012  
Vehicle code: ZVW30\*-AHXEBW  
Part number: PZ415-G0521-00

**!**  
**CHECK SIZE**  
Print 100%  
Check with rulers  
before use.

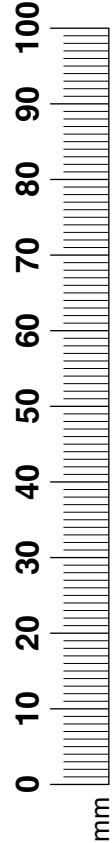

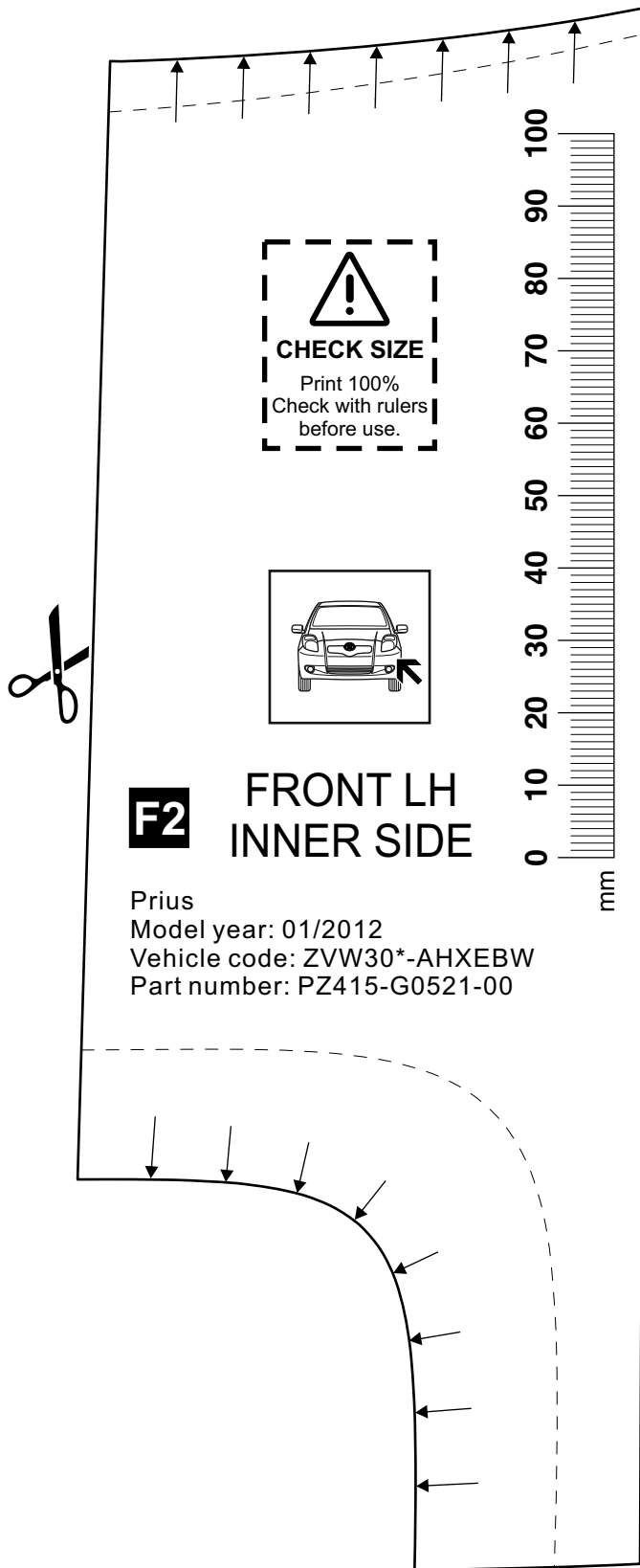

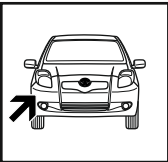
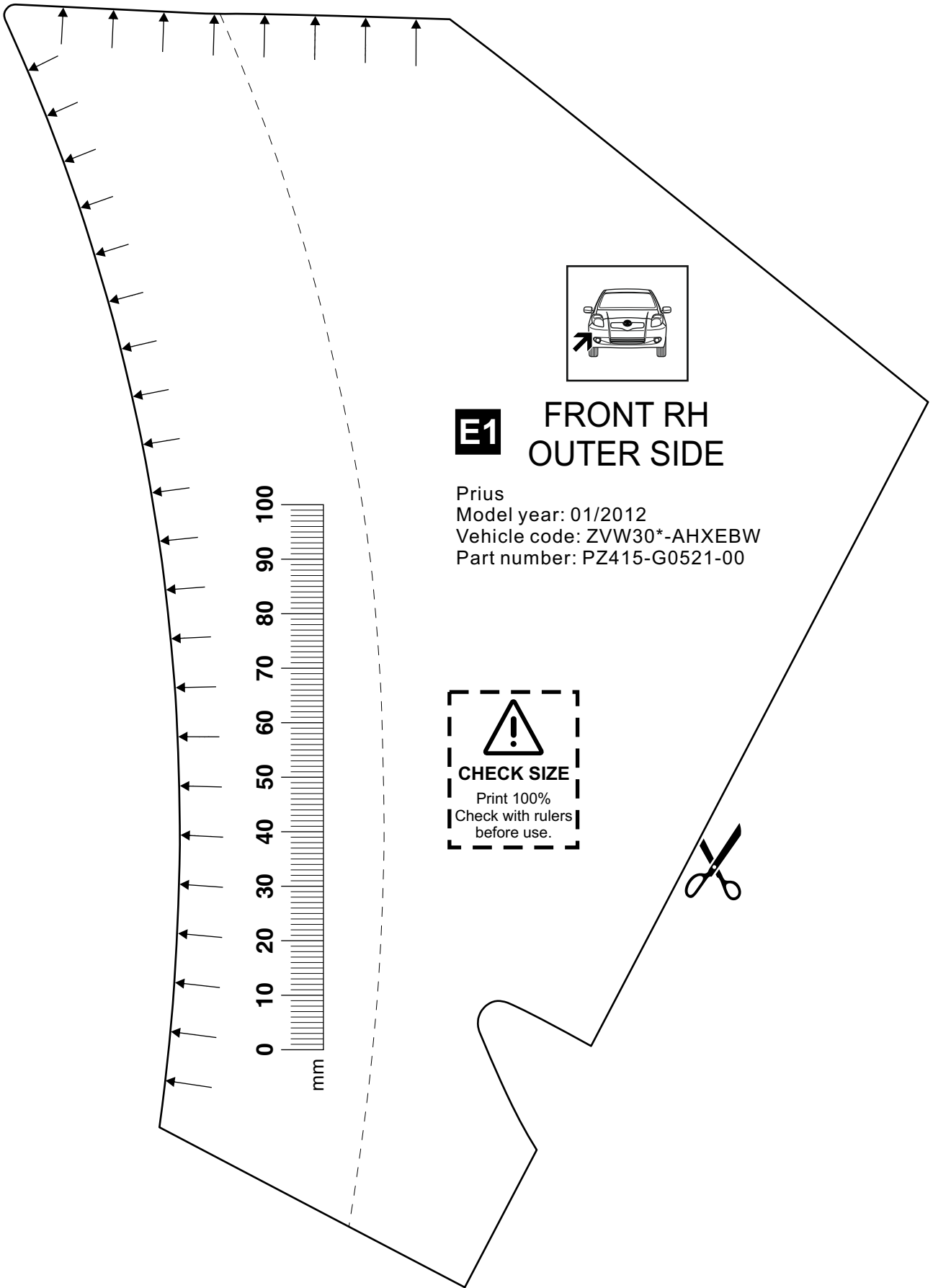

**E1**

# FRONT RH OUTER SIDE

Prius  
Model year: 01/2012  
Vehicle code: ZVW30\*-AHXEBW  
Part number: PZ415-G0521-00

  
**CHECK SIZE**  
Print 100%  
Check with rulers  
before use.



