



TOYOTA

ALWAYS A
BETTER WAY

Auris Touring Sports

Bumper corner protectors

Installation Instruction

Model year: 2013/06
Vehicle code: **E18**-DW***W
Part number: PZ49U-E5520-00

Manual reference number: AIM 002 855 - 0

Revision Record

Rev. No.	Date	Page	Picture	Update	New	Deleted steps

Compatibility Record

Toyota Parking Aid sensors = OK

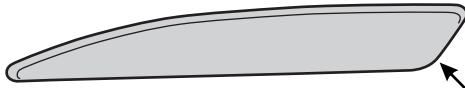

FRONT LH

A

PZ49U-E2520-02

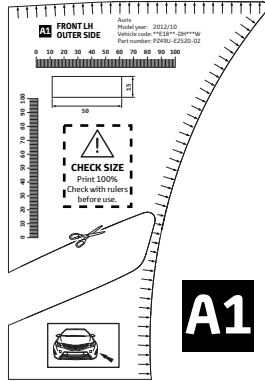

A1



B

REAR LH

PZ49U-E5520-04

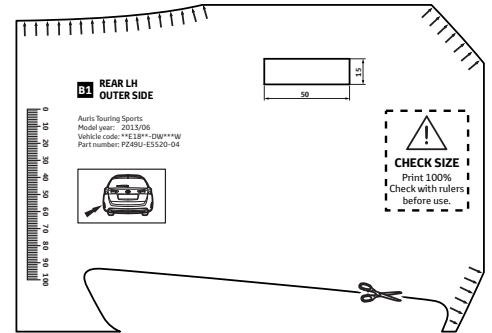

B1

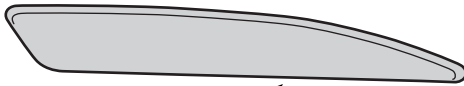

C

FRONT RH

PZ49U-E2520-01

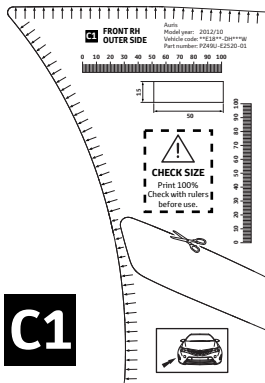

C1



D

REAR RH

PZ49U-E5520-03

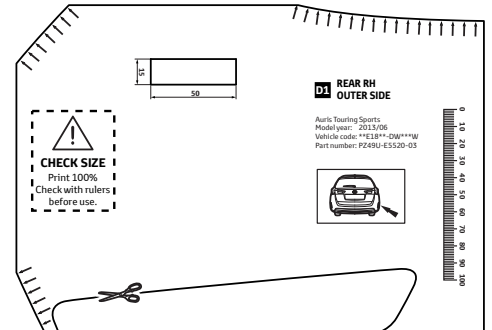

D1

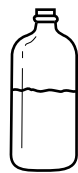
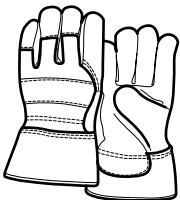

3M VHB Cleaner

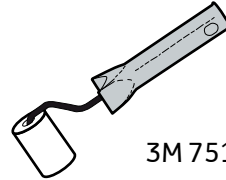

3M 751



3M 2010

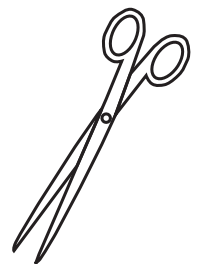
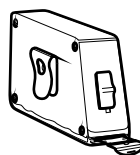
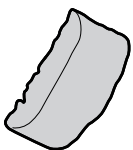

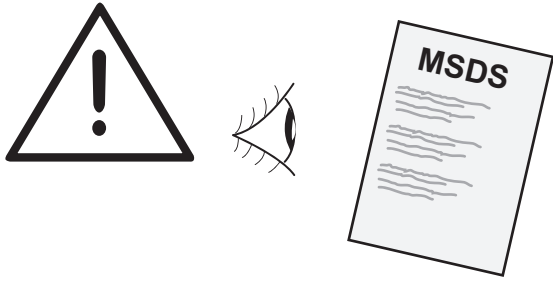

1

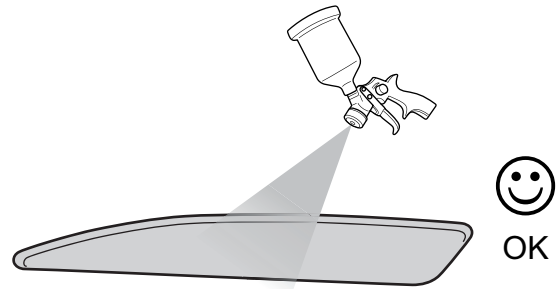
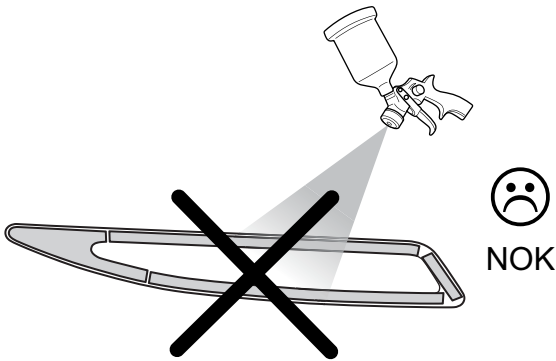
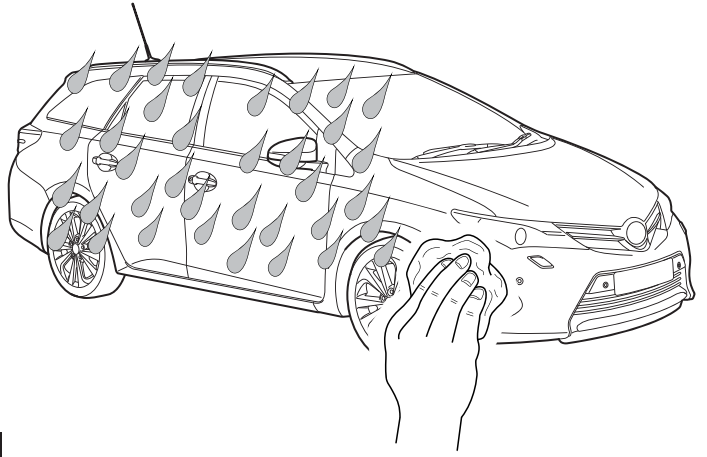

2

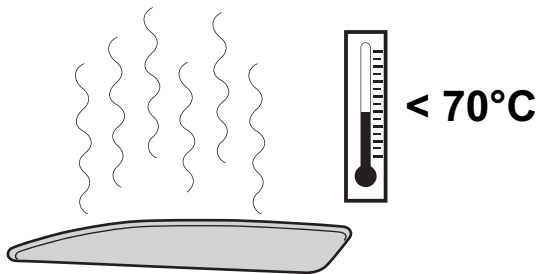

3

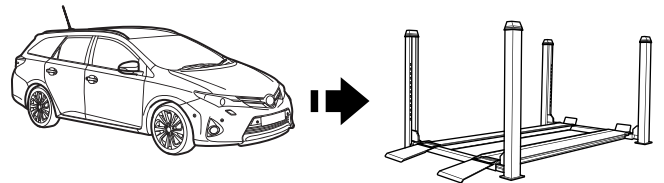

4

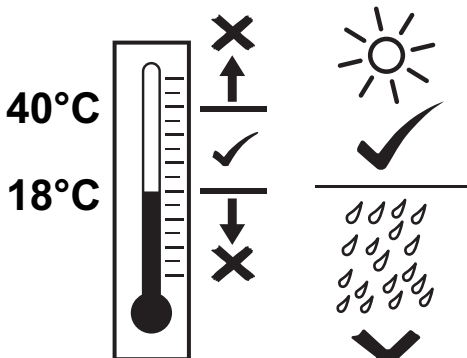

5

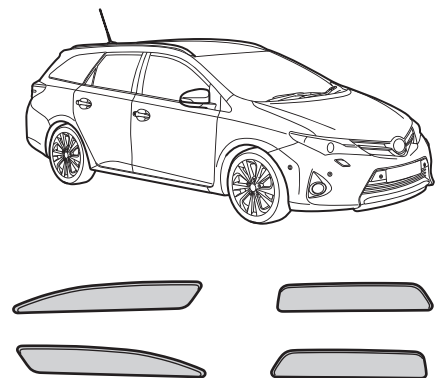

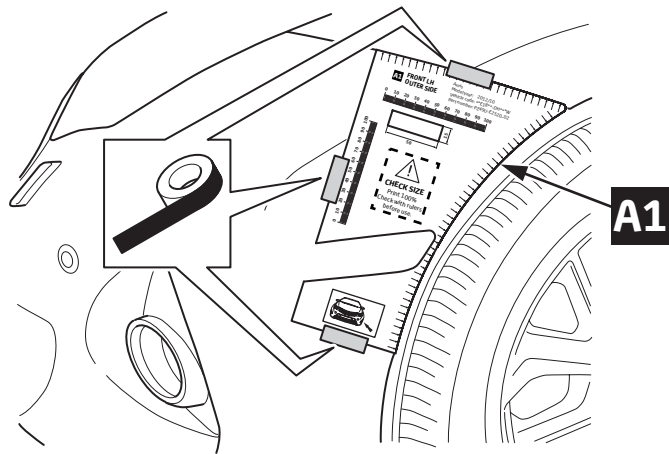

6

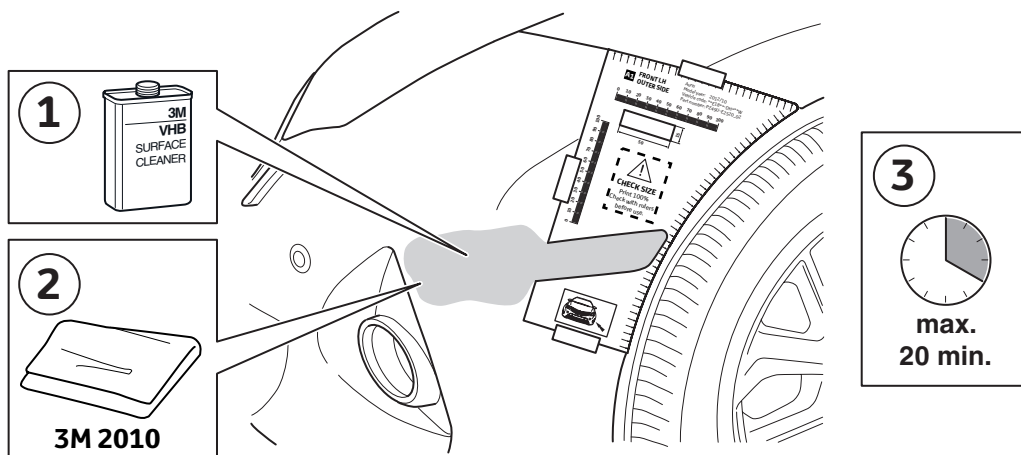

7

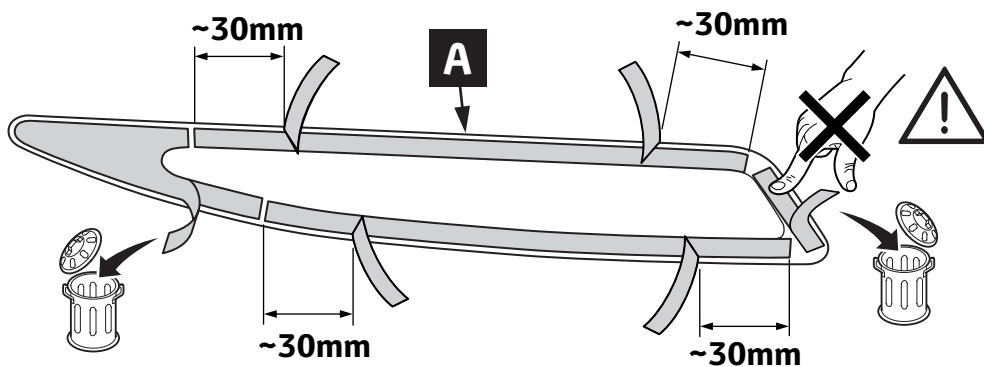

8

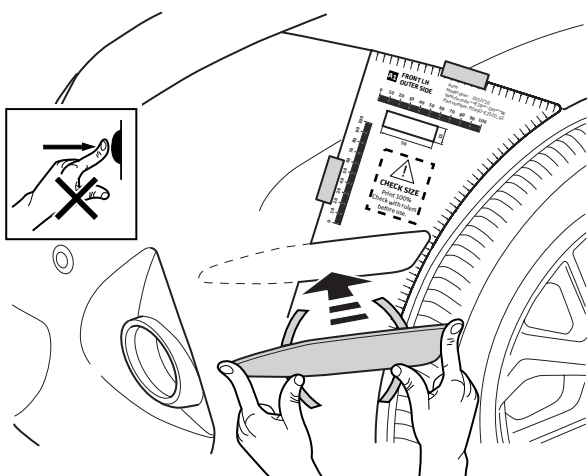

9

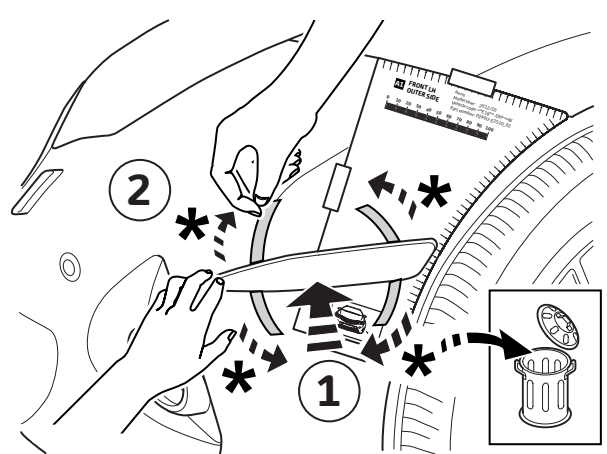

10

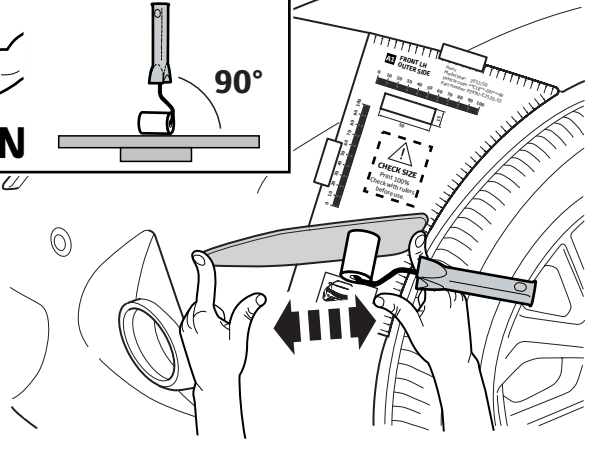
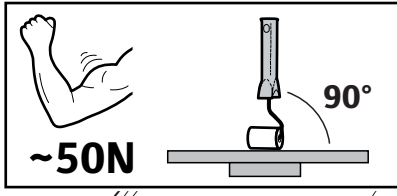

11

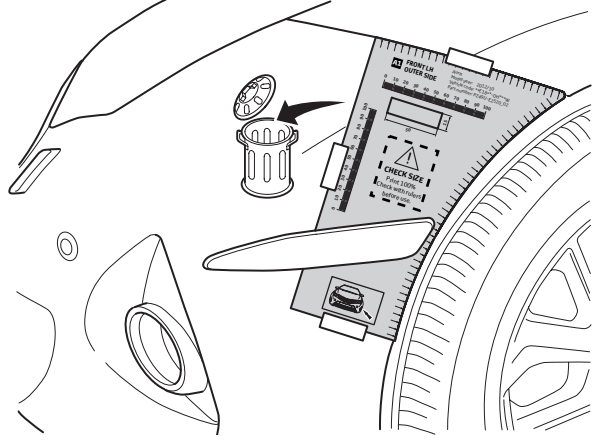

12

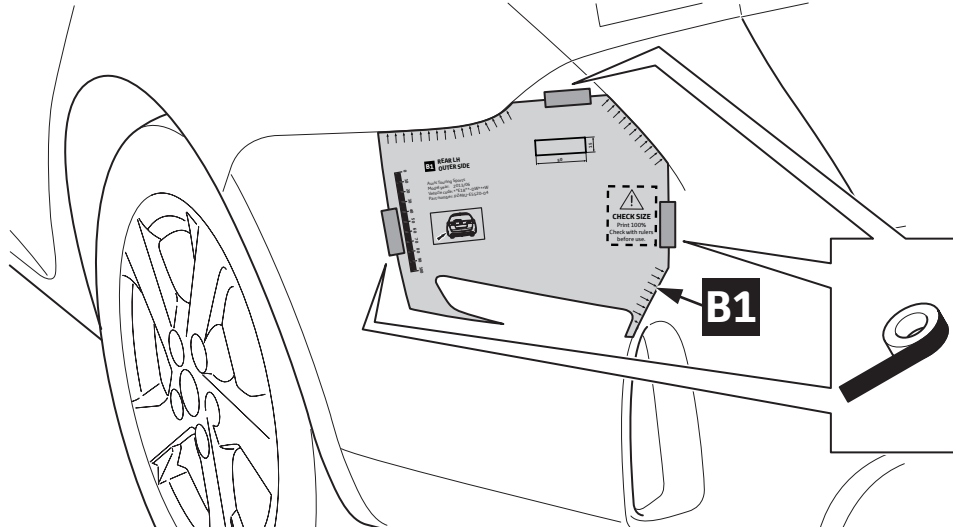

13

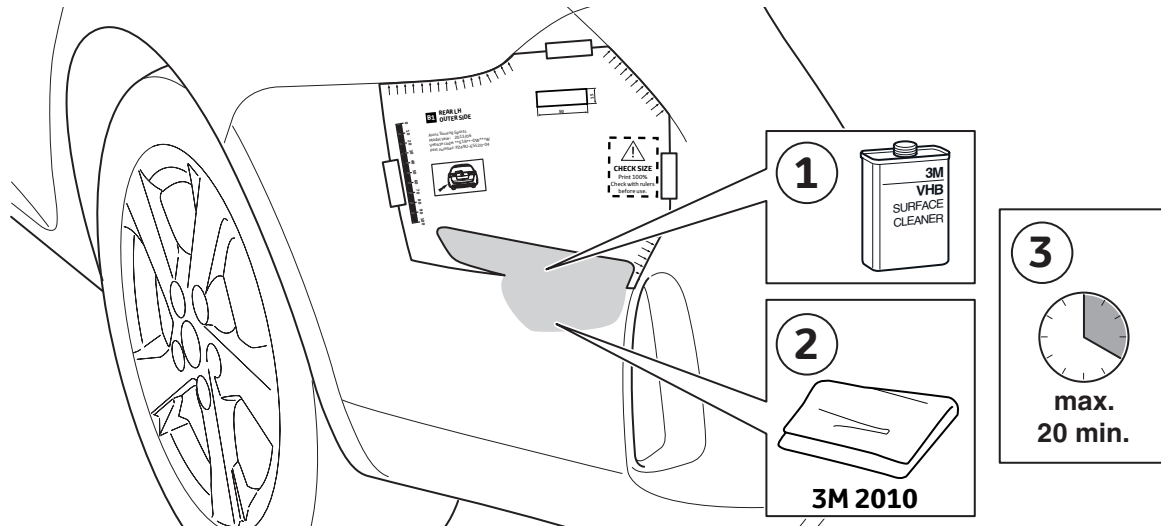

14

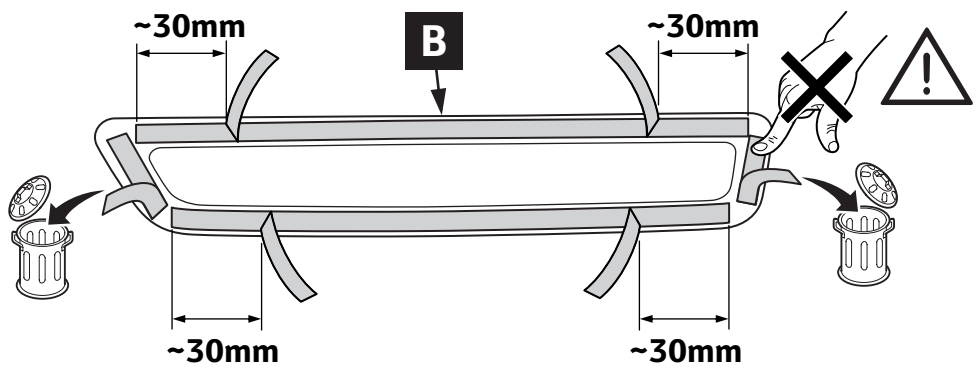

15

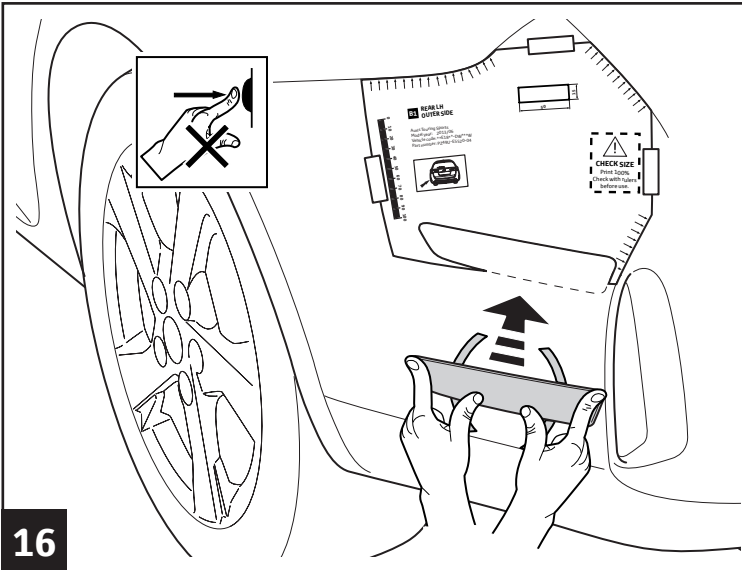

16

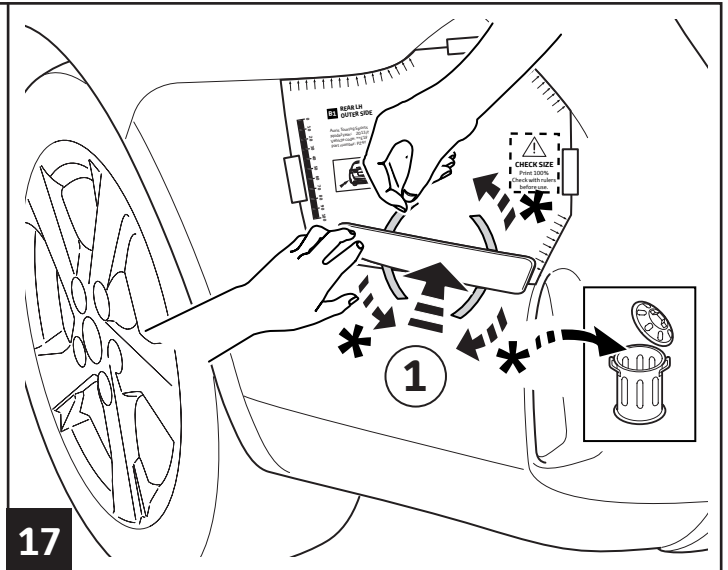

17

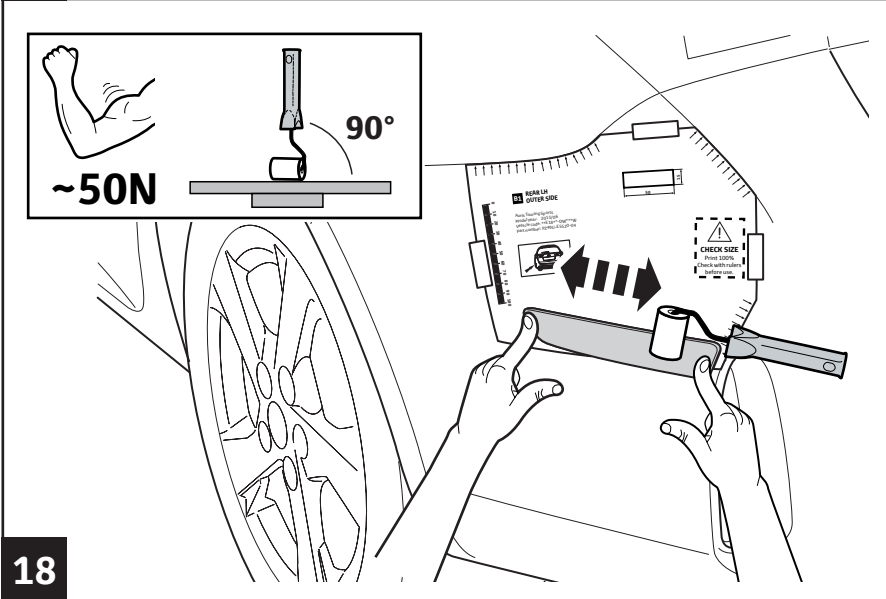

18

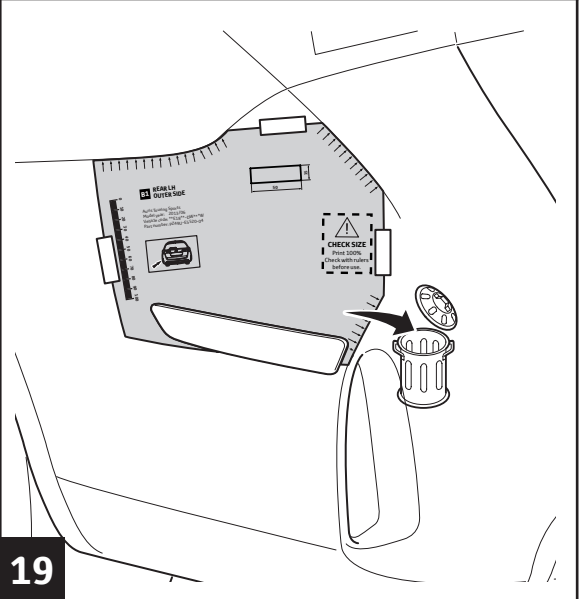

19

Fig.1 - Fig.19

RHS

=

Fig.1 - Fig.19

LHS

C

D

A

B

C1

D2

A1

B2

20



5 min.



72 h

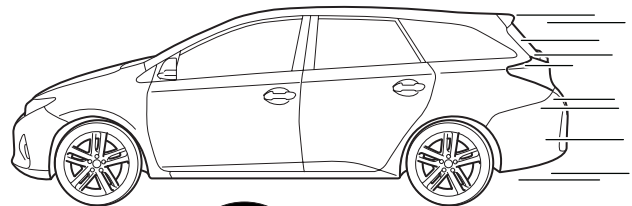
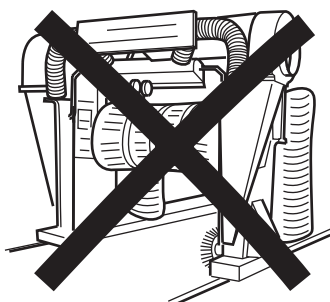

24 h

21

PAINTING INSTRUCTION PP TEXTURED PARTS

1. Mask the adhesive tape completely before painting.
2. Bake for 60 min at 70 °C.
3. Clean several times with plenty of fresh **Standoflex Thinner 11100** and an ultra fine pad.
4. Wet sand-papering (Scotch Brite: grey or red).
5. Reclean with **Standoflex Thinner 11100**.
6. Allow to dry completely.
7. Apply one coat of **Standoflex Plastic Primer Silver**.
8. Flash off.
9. Apply **2K HS Repair Filler** with 15% **2K Plastic Additive** together with **2K HS Hardener 3945**.
Apply two coats to completely remove the structure.
10. Bake for 45 min at 60 °C.
11. Dry sand paper with P400.
12. Apply **Standohyd Basecoat**.
13. Flash off.
14. Apply **2K HS Clear** with 10% **2K Plastic Additive** together with **2K HS Hardener 3945**.
15. Bake for 45 min at 60 °C.

LACKIERANWEISUNGEN FÜR STRUKTURIERTE PP-TEILE

1. Maskieren das Klebeband vollständig vor dem Lackieren.
2. 60 Min. bei 70 °C einbrennen.
3. Mehrere Male mit reichlich frischem **Standoflex Verdünner 11100** und einem ultrafeinen Pad reinigen.
4. Nass schleifen (Scotch Brite: grau oder rot).
5. Erneut mit **Standoflex Verdünner 11100** reinigen.
6. Vollständig trocknen lassen.
7. Eine Schicht **Standoflex Kunststoff-Primer Silver** auftragen.
8. Ablüften lassen.
9. **2K HS Reparaturspachtel** mit 15% **2K Kunststoffzusatz** zusammen mit **2K HS Härter 3945** auftragen.
Zwei Schichten auftragen, sodass die Strukturierung vollständig verschwunden ist.
10. 45 Min. bei 60 °C einbrennen.
11. Mit Körnung P400 schleifen.
12. **Standohyd Grundlack** auftragen.
13. Ablüften lassen.
14. **2K HS Klarlack** mit 10% **2K Kunststoffzusatz** zusammen mit **2K HS Härter 3945** auftragen.
15. 45 Min. bei 60 °C einbrennen.

INSTRUCTIONS DE PEINTURE DES PARTIES TEXTUREES PP

1. Masquer complètement le ruban adhésif avant de peindre.
2. Cuire à 70 °C pendant 60 min.
3. Nettoyer plusieurs fois en utilisant abondamment du **Standoflex Thinner 11100** neuf et un tampon ultrafin.
4. Poncer à l'eau (Scotch Brite: gris ou rouge).
5. Nettoyer à nouveau avec du **Standoflex Thinner 11100**.
6. Laisser complètement sécher.
7. Appliquer une couche de **Standoflex Plastic Primer Silver**.
8. Sécher superficiellement.
9. Appliquer du **2K HS Repair Filler** avec 15% de **2K Plastic Additive** conjointement avec du **2K HS Hardener 3945**.
Appliquer deux couches pour éliminer totalement la structure.
10. Cuire à 60 °C pendant 45 min.
11. Poncer à sec avec du P400.
12. Appliquer du **Standohyd Basecoat**.
13. Sécher superficiellement.
14. Appliquer du **2K HS Clear** avec 10% de **2K Plastic Additive** conjointement avec du **2K HS Hardener 3945**.
15. Cuire à 60 °C pendant 45 min.

ISTRUZIONI DI VERNICIATURA PARTI GRANULATE PP

1. Mascherare completamente il nastro biadesivo prima del processo di verniciatura.
2. Cuocere per 60 minuti a 70 °C.
3. Pulire parecchie volte con abbondante **Standoflex Thinner 11100** e un tampone abrasivo ultrafine.
4. Cartavetrare a umido (Scotch Brite: grigio o rosso).
5. Ripulire con **Standoflex Thinner 11100**.
6. Permettere che si essichi completamente.
7. Applicare una mano di **Standoflex Plastic Primer Silver**.
8. Lasciar asciugare finché diventa opaco.
9. Applicare **2K HS Repair Filler** con **2K Plastic Additive** al 15% insieme a **2K HS Hardener 3945**.
Applicare due mani per rimuovere completamente la struttura.
10. Cuocere per 45 minuti a 60 °C.
11. Cartavetrare a secco con P400.
12. Applicare **Standohyd Basecoat**.
13. Lasciar asciugare finché diventa opaco.
14. Applicare **2K HS Clear** con **2K Plastic Additive** al 10% insieme a **2K HS Hardener 3945**.
15. Cuocere per 45 minuti a 60 °C.

INSTRUCCIONES PARA LA PINTURA DE PIEZAS CON TEXTURA PP

1. La cinta adhesiva de enmascarar por completo antes de pintar.
2. Caliente durante 60 minutos a 70 °C.
3. Limpie varias veces con abundante **Standoflex Thinner 11100** fresco y una almohadilla ultrafina.
4. Lijado húmedo (Scotch Brite: gris o rojo).
5. Vuelva a limpiar con **Standoflex Thinner 11100**.
6. Deje secar completamente.
7. Aplique una capa de **Standoflex Plastic Primer Silver**.
8. Vaporice.
9. Aplique **2K HS Repair Filler** con un 15% de **2K Plastic Additive** junto con **2K HS Hardener 3945**.
Aplique dos capas para quitar toda la estructura.
10. Caliente durante 45 minutos a 60 °C.
11. Lije en seco con P400.
12. Aplique **Standohyd Basecoat**.
13. Vaporice.
14. Aplique **2K HS Clear** con un 10% de **2K Plastic Additive** junto con **2K HS Hardener 3945**.
15. Caliente durante 45 minutos a 60 °C.

INSTRUÇÕES PARA PINTAR PEÇAS TEXTURIZADAS DE PP

1. Mascaram a fita adesiva completamente antes de pintar.
2. Cozer durante 60 minutos a 70 °C.
3. Limpar várias vezes com bastante **Standoflex Thinner 11100** e uma almofada ultra-fina.
4. Humedecer a lixa (Scotch Brite: cinzento ou vermelho).
5. Voltar a limpar com **Standoflex Thinner 11100**.
6. Deixar secar completamente.
7. Aplicar uma camada de **Standoflex Plastic Primer Silver**.
8. Retirar o brilho.
9. Aplicar **2K HS Repair Filler** com 15% de **2K Plastic Additive** juntamente com **2K HS Hardener 3945**.
Aplicar duas camadas para remover completamente a estrutura.
10. Cozer durante 45 minutos a 60 °C.
11. Utilizar uma lixa seca com P400.
12. Aplicar **Standohyd Basecoat**.
13. Retirar o brilho.
14. Aplicar **2K HS Clear** com 10% de **2K Plastic Additive** juntamente com **2K HS Hardener 3945**.
15. Cozer durante 45 minutos a 60 °C.

RICHTLIJNEN VOOR HET SCHILDEREN VAN PP TEXTUURDELEN

1. Volledig maskeren het plakband voor het schilderen.
2. Gedurende 60 min bakken op 70 °C.
3. Verschillende malen reinigen met zuivere **Standoflex Thinner 11100** en een extra fijne spons.
4. Gebruik nat schuurpapier (Scotch Brite: grijs of rood).
5. Opnieuw reinigen met **Standoflex Thinner 11100**.
6. Laat volledig drogen.
7. Breng een laag **Standoflex Plastic Primer Silver** aan.
8. Licht afschuren.
9. Breng **2K HS Repair Filler** aan met 15% **2K Plastic Additive** samen met **2K HS Hardener 3945**.
Breng twee lagen aan om de structuur volledig te doen verdwijnen.
10. Bak gedurende 45 min op 60 °C.
11. Gebruik droog schuurpapier P400.
12. Breng een **Standohyd Basecoat** aan.
13. Licht afschuren.
14. Breng **2K HS Clear** aan met 10% **2K Plastic Additive** samen met **2K HS Hardener 3945**.
15. Bak gedurende 45 min op 60 °C.

MALEVEJLEDNING PP-EFFEKTDLE

1. Maskere tape helt før maling.
2. Bag i 60 min. ved 70 °C.
3. Rengør flere gange med rigeligt frisk **Standoflex Thinner 11100** (fortynder) og en meget fin svamp.
4. Lav våd slibning med sandpapir (Scotch Brite: grå eller rød).
5. Gør ren igen med **Standoflex Thinner 11100** (fortynder).
6. Lad den tørre helt.
7. Påfør et lag **Standoflex Plastic Primer Silver** (grunder).
8. Lad det fordampe.
9. Påfør **2K HS Repair Filler** (spartelmasse) med 15% **2K Plastic Additive** (plasttilsætning) sammen med **2K HS Hardener 3945** (hærdemiddel) Påfør to lag mere for helt at fjerne strukturen.
10. Bag i 45 min. ved 60 °C.
11. Slib med tørt sandpapir P400.
12. Påfør **Standohyd Basecoat** (underlag).
13. Lad det fordampe.
14. Påfør **2K HS Clear** (klar) med 10% **2K Plastic Additive** (plasttilsætning) sammen med **2K HS Hardener 3945** (hærdemiddel).
15. Bag i 45 min. ved 60 °C.

LACKERINGSANVISNING, PP-DELAR MED STRUKTURERAD YTA

1. Maskera tejpén helt innan målning.
2. Värm i 60 min och 70 °C.
3. Rengör upprepade gånger med flödigt av färsk **Standoflex Thinner 11100** och en mycket fin dyna.
4. Våt slipa (Scotch Brite; grå eller röd).
5. Rengör igen med **Standoflex Thinner 11100**.
6. Låt torka fullständigt.
7. Applicera ett lager av **Standoflex Plastic Primer Silver**.
8. Låt torka.
9. Applicera **2K HS Repair Filler** med 15% **2K Plastic Additive** blandat med **2K HS Hardener 3945**. Applicera två lager för att jämna ut ytan helt.
10. Härd i 45 min och 60 °C.
11. Slipa med torrt sandpapper P400.
12. Applicera **Standohyd Basecoat**.
13. Låt torka.
14. Applicera **2K HS Clear** med 10% **2K Plastic Additive** blandat med **2K HS Hardener 3945**.
15. Härd i 45 min och 60 °C.

MAALAUOHJE, PP-KUVIOIDUT OSAT

1. Peittää teippi kokonaan ennen maalausta.
2. Paista 70 °C:ssa 60 minuuttia.
3. Puhdista useita kertoja käyttämällä runsaasti puhdasta **Standoflex Thinner 11100** -ohennetta ja erityishienoa tyynyä.
4. Hio märkähiomapaperilla (harmaa tai punainen Scotch-Brite).
5. Puhdista uudelleen **Standoflex Thinner 11100** -ohenteella.
6. Anna kuivua täysin.
7. Levitä yksi kerros **Standoflex Plastic Primer Silver** -pohjamaalia.
8. Anna haihtua.
9. Levitä **2K HS Repair Filler** -täyteainetta, jossa on 15 % **2K Plastic Additive** -lisäainetta, ja **2K HS Hardener 3945** -kovetinta. Levitä kaksi kerrosta, jotta kuvioinnin rakenne poistuu täysin.
10. Paista 60 °C:ssa 45 minuuttia.
11. Hio tavallisella P400-hiomapaperilla.
12. Levitä **Standohyd Basecoat** -pohjustus.
13. Anna haihtua.
14. Levitä **2K HS Clearia**, jossa on 10% **2K Plastic Additive** -lisäainetta, ja **2K HS Hardener 3945** -kovetinta.
15. Paista 60 °C:ssa 45 minuuttia.

MALERINSTRUKSER FOR DELER MED PP-STRUKTUR

1. Maskere tape helt før maling.
2. Ovnstørk i 60 minutter ved 70 °C.
3. Rengjør gjentatte ganger med store mengder ren tynner av typen **Standoflex Thinner 11100** og en ultrafin sudd.
4. Bruk vått sandpapir (Scotch Brite: grått eller rødt).
5. Rengjør på nytt med **Standoflex Thinner 11100**.
6. La stå og tørke til helt tørt.
7. Påfør ett lag med grunning av typen **Standoflex Plastic Primer Silver**.
8. Jevn ut.
9. Påfør **2K HS Repair Filler** med 15% **2K Plastic Additive** sammen med herder av typen **2K HS Hardener 3945**. Påfør to lag, slik at all struktur jevnes ut.
10. Ovnstørk i 45 minutter ved 60 °C.
11. Puss med tørt sandpapir av typen P400.
12. Påfør **Standohyd Basecoat**.
13. Jevn ut.
14. Påfør **2K HS Clear** med 10% **2K Plastic Additive** sammen med herder av typen **2K HS Hardener 3945**.
15. Ovnstørk i 45 minutter ved 60 °C.

POKYNY K LAKOVÁNÍ DÍLŮ Z PP S TEXTUROU

1. Maskovat lepicí pásky zcela před nátěrem.
2. Pečte po dobu 60 min při teplotě 70 °C.
3. Několikrát vyčistěte dostatečným množstvím čerstvého ředidla **Standoflex 11100** a velice jemným hadříkem.
4. Za mokra povrch obruste (Scotch Brite: šedý nebo červený).
5. Znovu vyčistěte ředidlem **Standoflex 11100**.
6. Nechejte povrch důkladně vyschnout.
7. Naneste jednu vrstvu laku **Standoflex Plastic Primer Silver**.
8. Odvětrejte.
9. Naneste **2složkový servisní tmel HS** s 15% **2složkovou přísadou na plasty** společně s **2složkovou tvrdicí přísadou HS 3945**. Naneste dvě vrstvy tak, aby struktura zcela zmizela.
10. Pečte po dobu 45 min při teplotě 60 °C.
11. Za sucha povrch obruste pomocí P400.
12. Naneste **základní nátěr Standohyd**.
13. Odvětrejte.
14. Naneste **2složkový průhledný lak HS** s 10% **2složkovou přísadou na plasty** společně s **2složkovou tvrdicí přísadou HS 3945**.
15. Pečte po dobu 45 min při teplotě 60 °C.

INSTRUKCJA LAKIEROWANIA FRAKTUROWANYCH CZĘŚCI Z POLIPROPYLENU

1. Maskować taśmę samoprzylepną całkowicie przed malowaniem.
2. Wypalać przez 60 min w temp. 70 °C.
3. Oczyszczyć kilkakrotnie za pomocą dużej ilości świeżego rozcieńczalnika **Standoflex Thinner 11100** i delikatnej drobnowłóknistej szmatki.
4. Zmatować na mokro papierem ściernym (Scotch Brite: szary lub czerwony).
5. Ponownie oczyścić za pomocą **Standoflex Thinner 11100**.
6. Odczekać, aż do całkowitego wyschnięcia.
7. Nanieść jedną warstwę podkładu **Standoflex Plastic Primer Silver**.
8. Odczekać, aż zwiąże.
9. Nanieść szpachlówkę 2-składnikową **2K HS Repair Filler** z 15% 2-składnikowym plastyfikatorem **2K Plastic Additive** razem z 2-składnikowym utwardzaczem **2K HS Hardener 3945**. Nanieść dwie warstwy, aby całkowicie usunąć strukturę.
10. Wypalać przez 45 min w temp. 60 °C.
11. Zmatować na sucho papierem ściernym o ziarnistości P400.
12. Nanieść podkład **Standohyd Basecoat**.
13. Odczekać, aż zwiąże.
14. Nanieść 2-składnikowy lakier bezbarwny **2K HS Clear** z 10% 2-składnikowym plastyfikatorem **2K Plastic Additive** razem z 2-składnikowym utwardzaczem **2K HS Hardener 3945**.
15. Wypalać przez 45 min w temp. 60 °C.

ИНСТРУКЦИЯ ПО ОКРАСКЕ ТЕКСТУРИРОВАННЫХ ПОЛИПРОПИЛЕНОВЫХ ДЕТАЛЕЙ

1. Замаскировать скотчем полностью перед покраской.
2. Сушить 60 мин при 70 °C.
3. Очистить несколько раз большим количеством свежего разбавителя **Standoflex Thinner 11100** с помощью сверхтонкой губки.
4. Мокрое ошкуривание (Scotch Brite: серая или красная).
5. Повторно очистить разбавителем **Standoflex Thinner 11100**.
6. Дать полностью просохнуть.
7. Нанести один слой грунтовки для пластмассы **Standoflex Plastic Primer Silver**.
8. Дать подсохнуть.
9. Нанести ремонтный порозаполнитель **2K HS Repair Filler** с 15% присадки для пластмассы **2K Plastic Additive** вместе с отвердителем **2K HS Hardener 3945**. Для полного скрытия структуры нанести два слоя.
10. Сушить 45 мин при 60 °C.
11. Сухое ошкуривание шкуркой P400.
12. Нанести базовую краску **Standohyd Basecoat**.
13. Дать подсохнуть.
14. Нанести прозрачный лак **2K HS Clear** с 10% присадки для пластмассы **2K Plastic Additive** вместе с отвердителем **2K HS Hardener 3945**.
15. Сушить 45 мин при 60 °C.

ΟΔΗΓΙΑ ΒΑΦΗΣ ΤΜΗΜΑΤΩΝ ΥΦΗΣ ΠΟΛΥΠΡΟΠΥΛΕΝΙΟΥ

1. Αποκρύψει την κολλητική ταινία εντελώς πριν από τη ζωγραφική.
2. Τοποθέτηση στο φούρνο επί 60 λεπτά στους 70 °C.
3. Καθαρισμός αρκετές φορές με άφθονη ποσότητα φρέσκου διαλυτικού **Standoflex Thinner 11100** και εξαιρετικά λεπτόκοκο γυαλόχαρτο.
4. Υγρή εκτριβή με γυαλόχαρτο (Scotch Brite: γκρι ή κόκκινο).
5. Εκ νέου καθαρισμός με διαλυτικό **Standoflex Thinner 11100**.
6. Αφήστε το στεγνώσει εντελώς.
7. Εφαρμογή μίας στρώσης **Standoflex Plastic Primer Silver**.
8. Εξαέρωση.
9. Εφαρμογή **2K HS Repair Filler** με 15% **2K Plastic Additive** μαζί με **2K HS Hardener 3945**. Εφαρμογή δύο στρώσεων για να αφαιρεθεί εντελώς το υπόστρωμα.
10. Τοποθέτηση στο φούρνο επί 45 λεπτά στους 60 °C.
11. Ξηρή εκτριβή με γυαλόχαρτο P400.
12. Εφαρμογή **Standohyd Basecoat**.
13. Εξαέρωση.
14. Εφαρμογή **2K HS Clear** με 10% **2K Plastic Additive** μαζί με **2K HS Hardener 3945**.
15. Τοποθέτηση στο φούρνο επί 45 λεπτά στους 60 °C.

BOYA TALİMATI PP DOKULU PARÇALAR

1. Boya öncesi tamamen yapıştırıcı bant maskeleyebilir.
2. 70°C'de 60 dak. fırınlayın.
3. Bir kaç kez bol miktarda taze **Standoflex Tiner 11100** ve ultra ince bir ped ile temizleyin.
4. Islak zımparalama (Scotch Brite: gri veya kırmızı).
5. **Standoflex Tiner 11100** ile tekrar temizleyin.
6. Tamamen kurumaya bırakın.
7. Bir kat **Standoflex Plastik Primer Silver** sürün.
8. Kurutun.
9. %15 **2K Plastik Katkı Maddesi** ve **2K HS Sertleştirici 3945** ile **2K HS Onarım Dolgusu** sürün. Yapıyı tamamen çıkartmak için iki kat sürün.
10. 60°C'de 45 dak. fırınlayın.
11. P400 ile kuru zımparalama.
12. **Standohyd Astar** sürün.
13. Kurutun.
14. %10 **2K Plastik Katkı Maddesi** ve **2K HS Sertleştirici 3945** ile **2K HS Saydam** sürün.
15. 60°C'de 45 dak. fırınlayın.

A1

**FRONT LH
OUTER SIDE**

Auris Touring Sports
Model year: 2013/06
Vehicle code: **E18**-DW***W
Part number: PZ49U-E2520-02

0 10 20 30 40 50 60 70 80 90 100

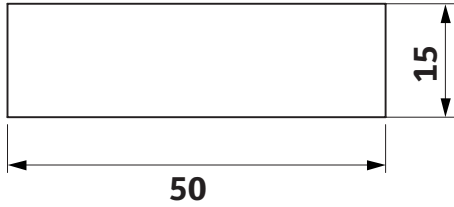
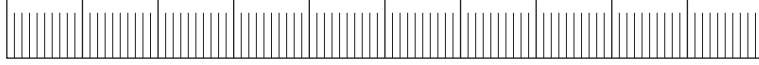

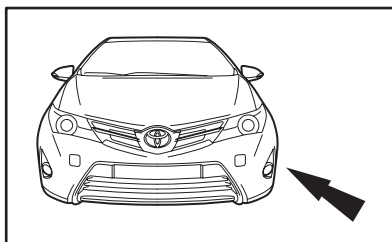

CHECK SIZE
Print 100%
Check with rulers
before use.

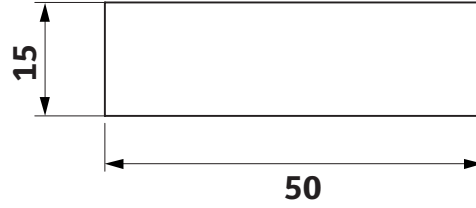
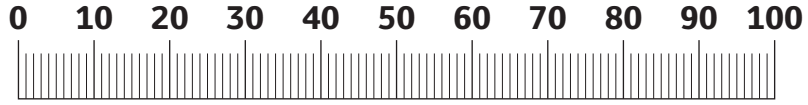

**C1 FRONT RH
OUTER SIDE**

Auris Touring Sports
Model year: 2013/06
Vehicle code: **E18**-DW***W
Part number: PZ49U-E2520-01



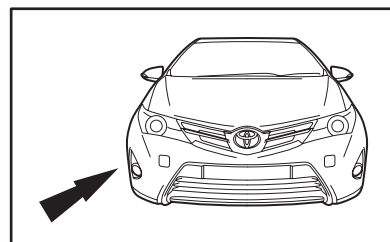
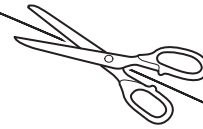

CHECK SIZE
Print 100%
Check with rulers
before use.

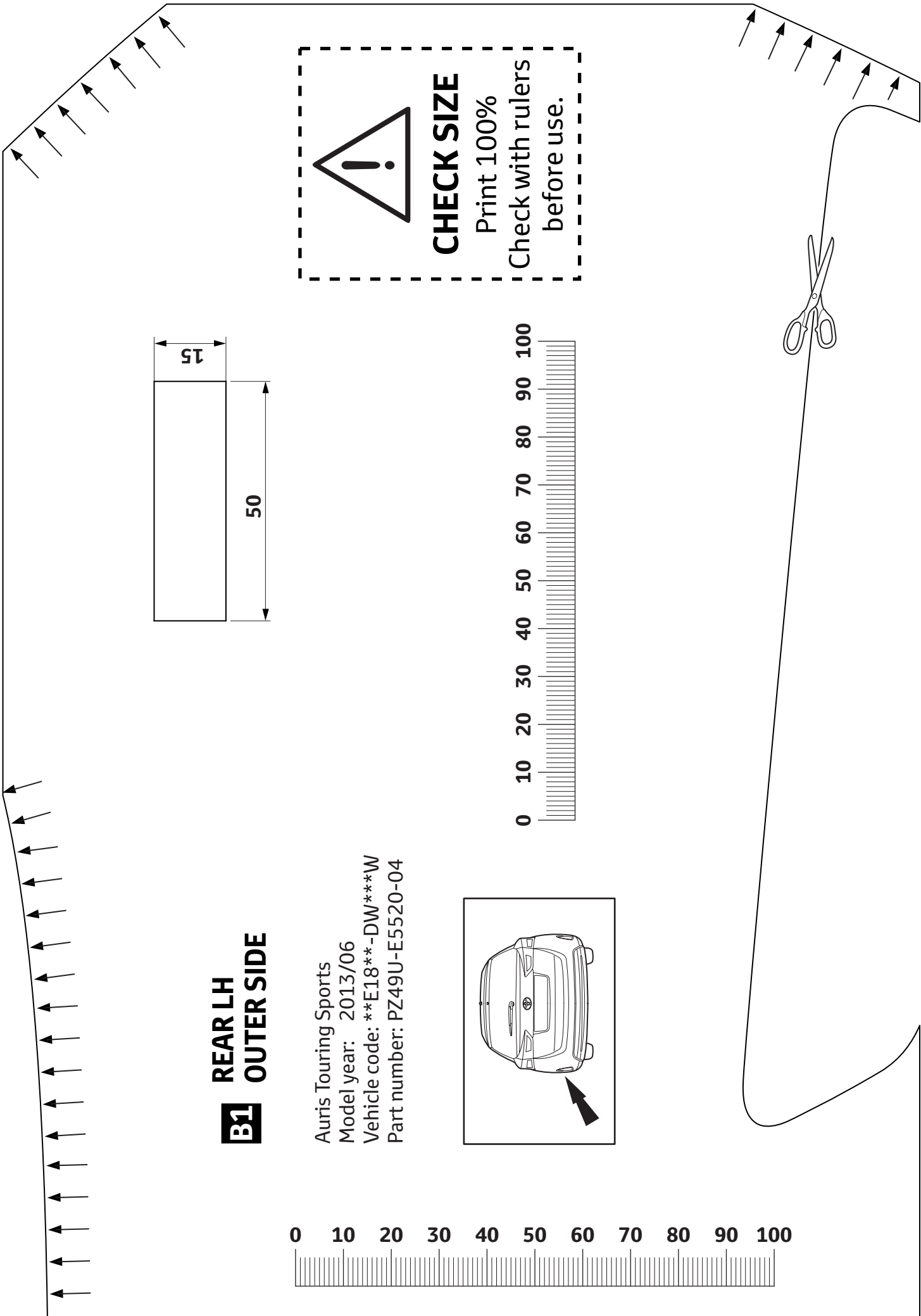

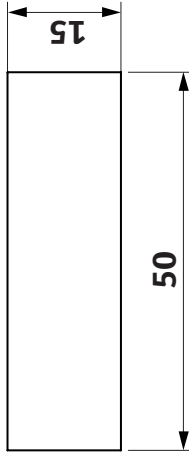
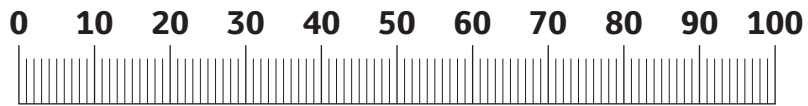
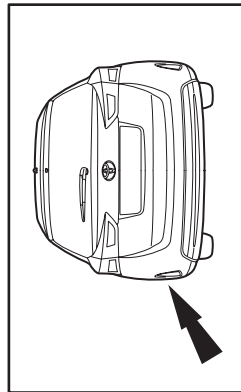

B1 REAR LH OUTER SIDE

Auris Touring Sports
Model year: 2013/06
Vehicle code: **E18**-DW***W
Part number: PZ49U-E5520-04





CHECK SIZE
Print 100%
Check with rulers
before use.

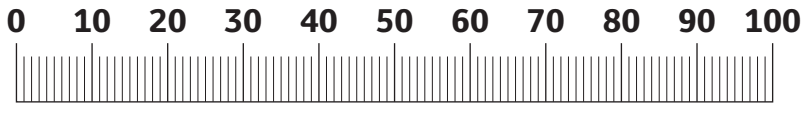
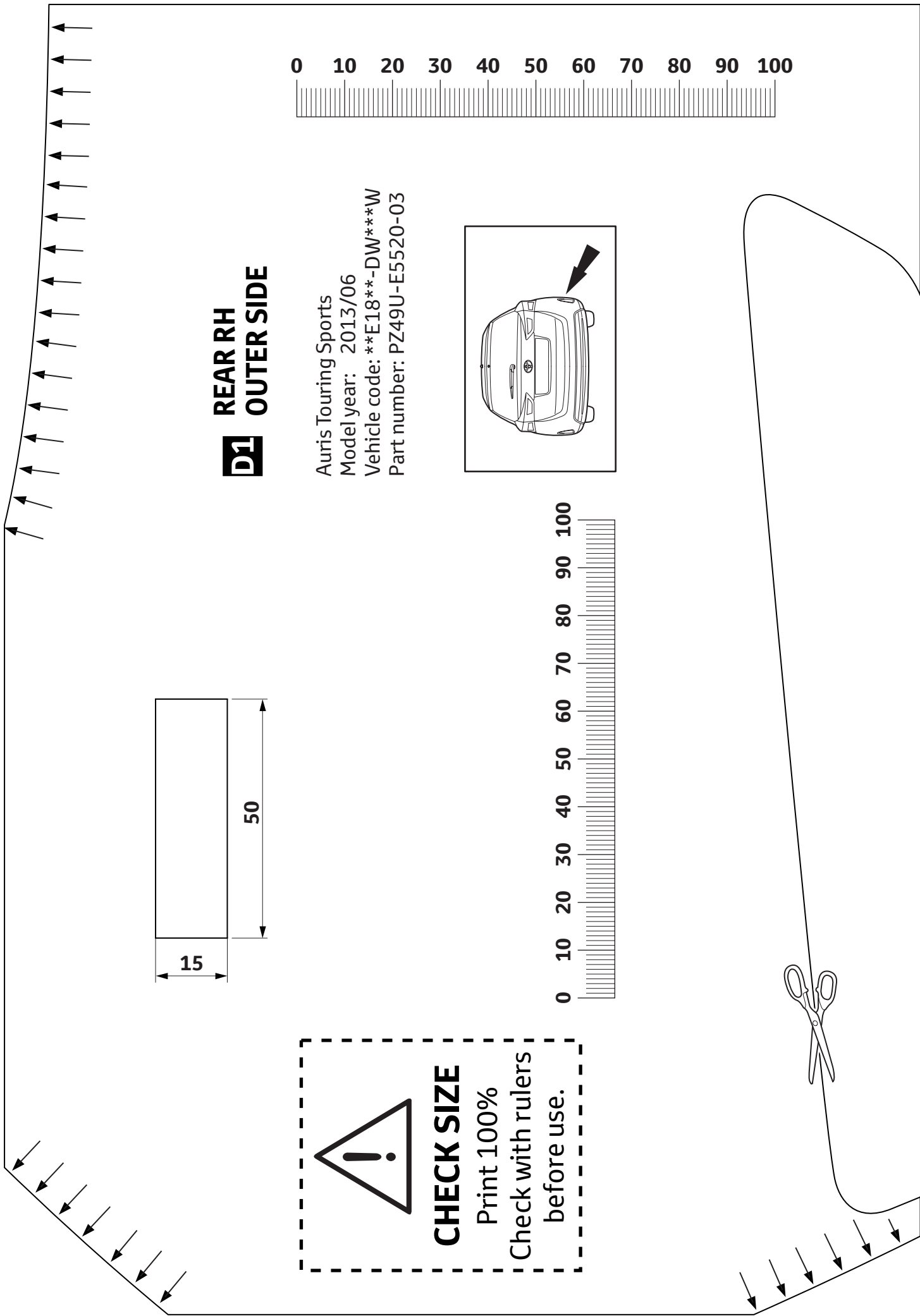

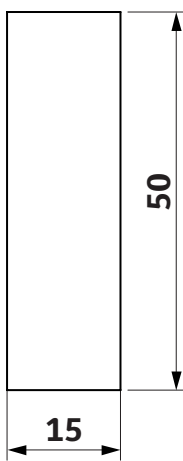
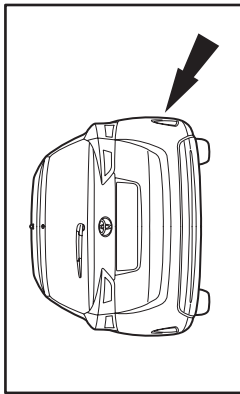

D1
REAR RH
OUTER SIDE

Auris Touring Sports
Model year: 2013/06
Vehicle code: **E18**-DW***W
Part number: PZ49U-E5520-03



CHECK SIZE
Print 100%
Check with rulers
before use.



CHECK SHEET



TOYOTA

Model / Year

**Auris Touring Sports
2013/06**

**Bumper Corner
Protectors**

ALWAYS A
BETTER WAY

VIN n°

P/N = OK

40°C
18°C

CLEANER

0 10 20 30 40 50 60 70 80 90 100

**Print 100%
Check with Rulers
before use.**

= OK

Installation Date:

... / ... / ...

Technician Name & Signature:

Stamp: