



TOYOTA

ALWAYS A
BETTER WAY

Rav4

Mudflaps

Installation Instructions

Model year: 2012/12
Vehicle code: **A4**-AN***W
Part number: PU060-42013-P1

Manual reference number: AIM 002 743-0

Revision record

Rev. No.	Date	Page	Picture	Update	New	Deleted steps

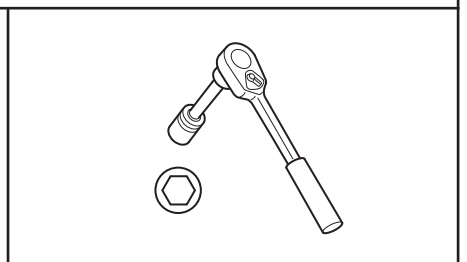
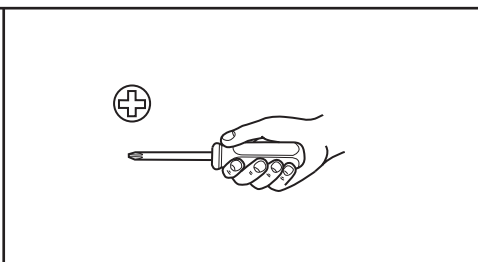
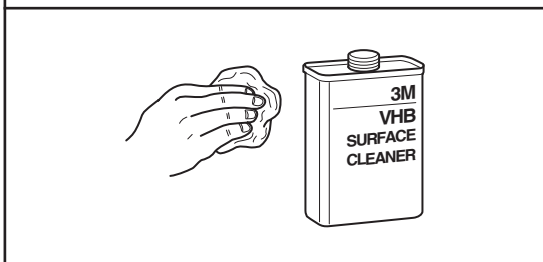
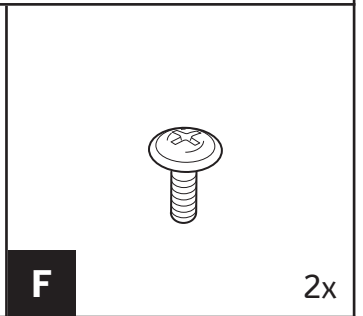
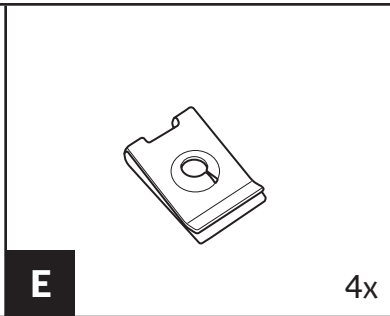
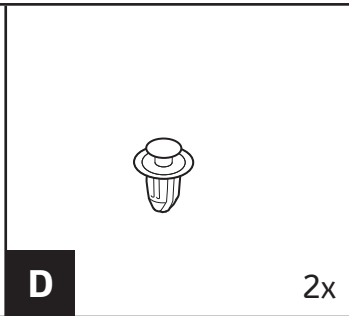
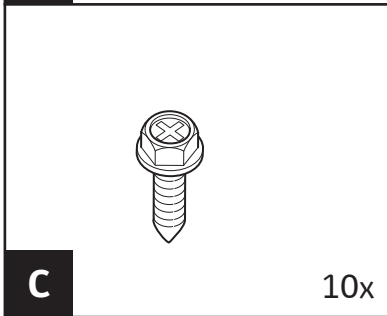
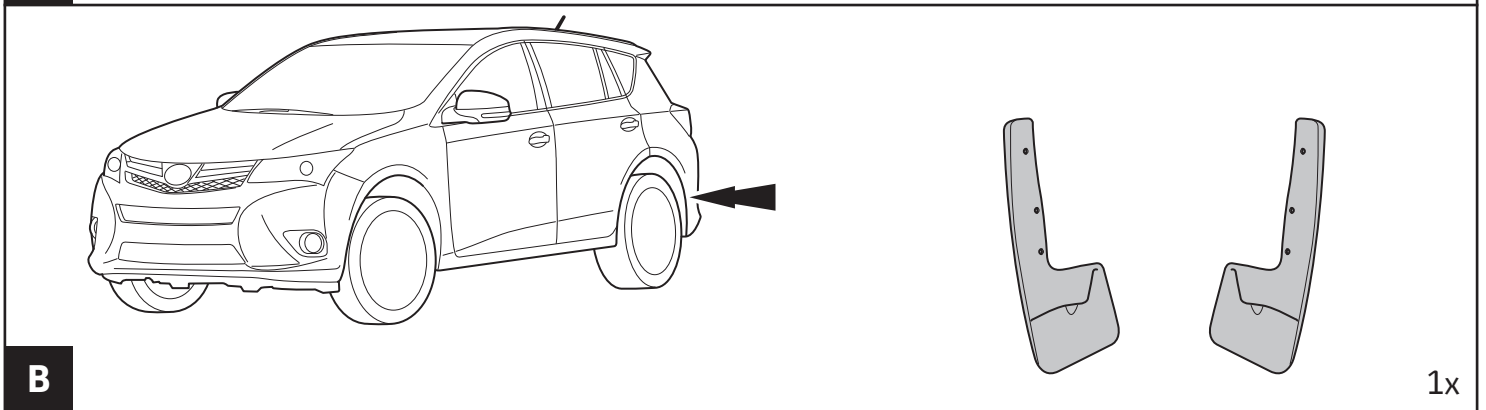
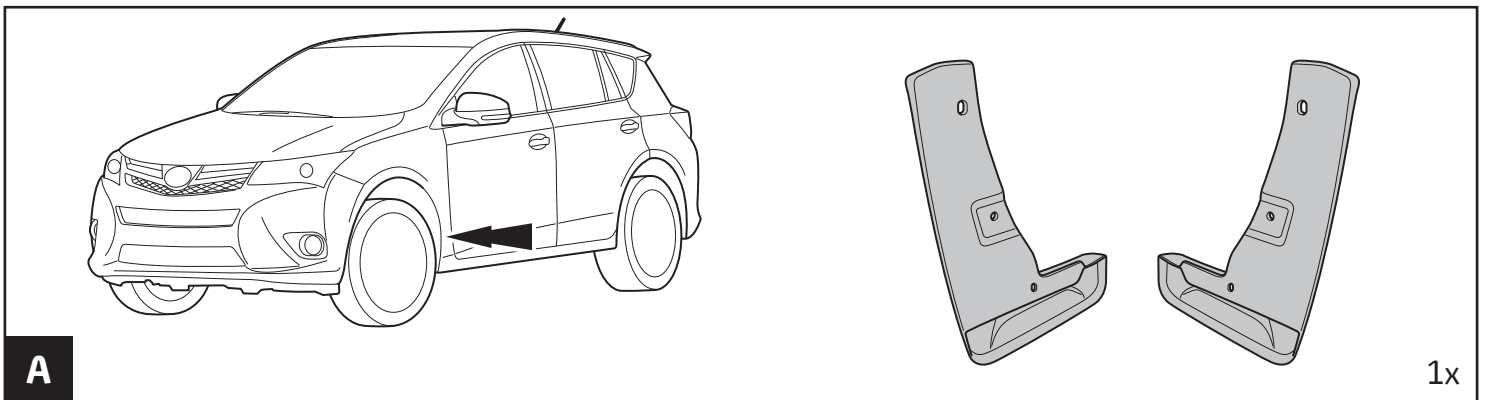

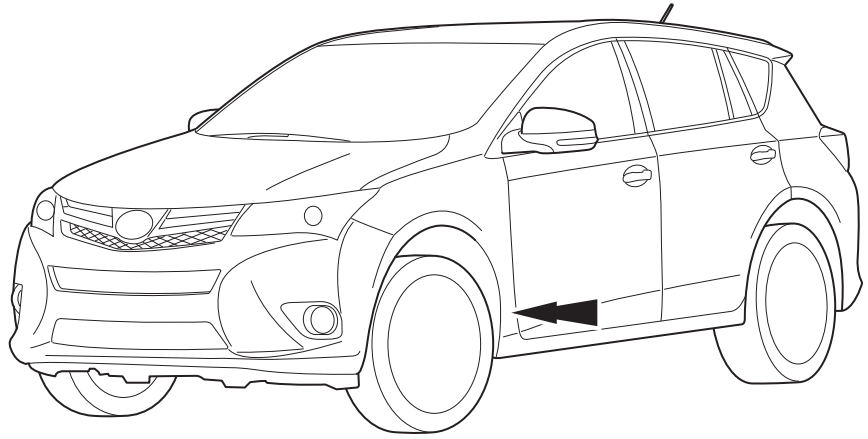
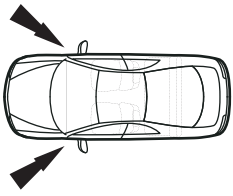

1

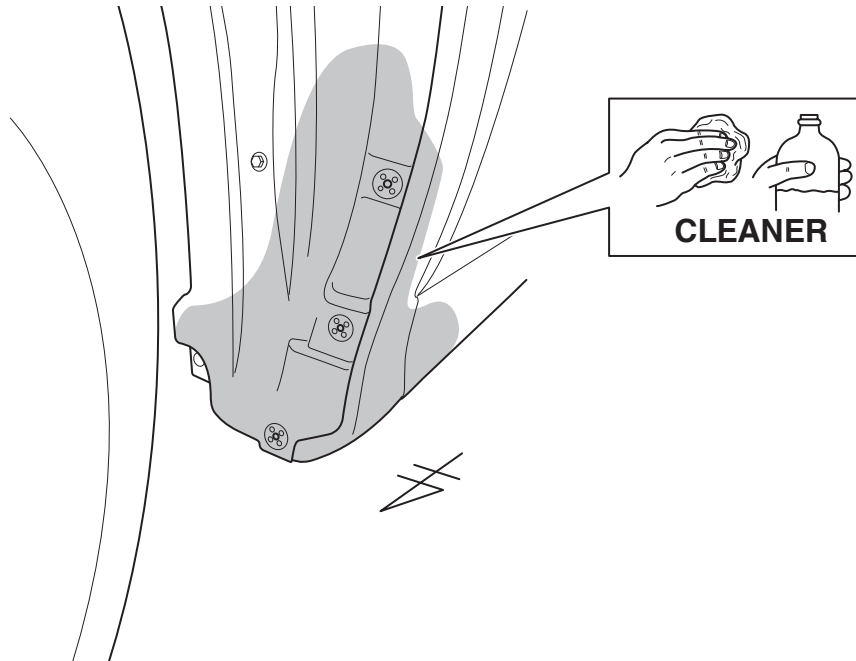

2

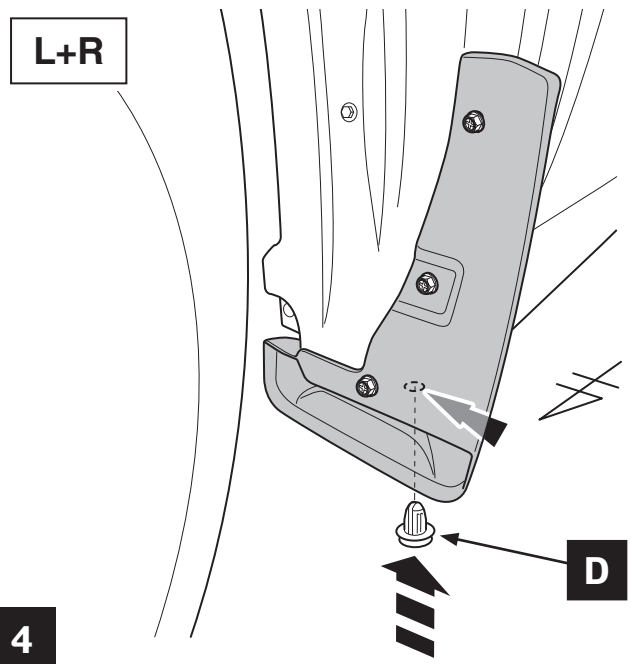
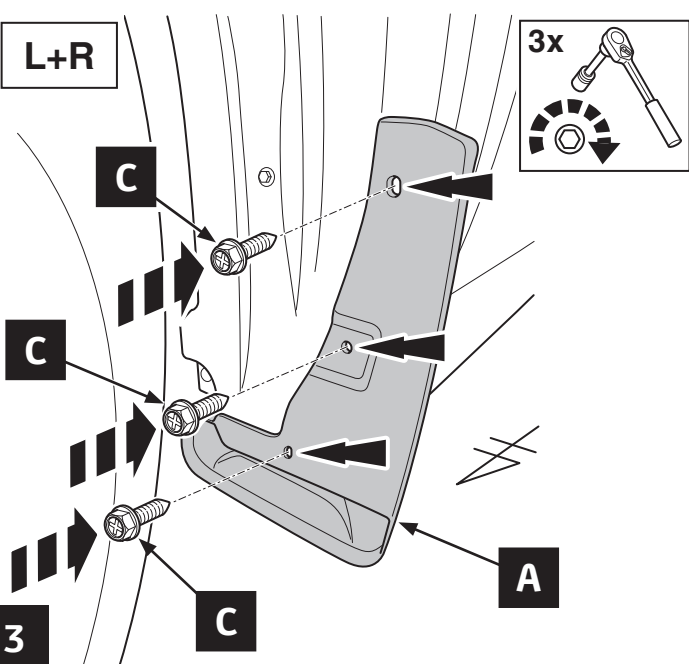

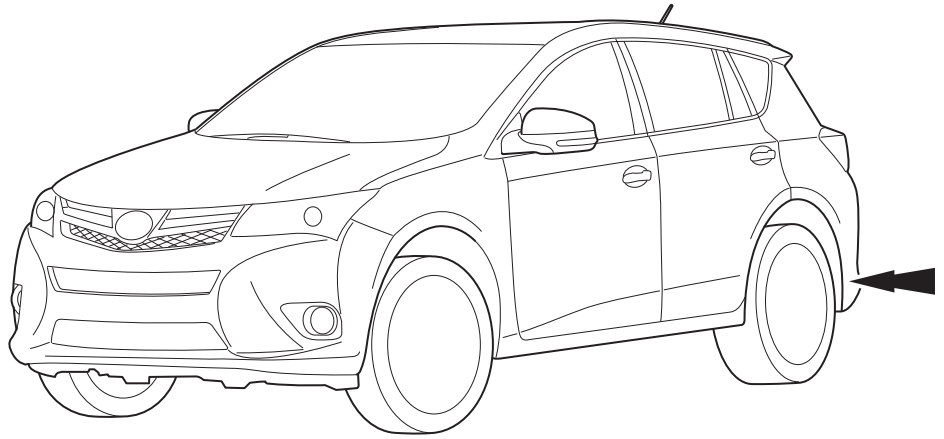
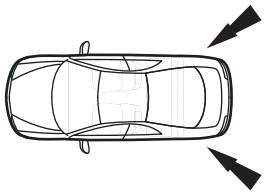

5

L+R

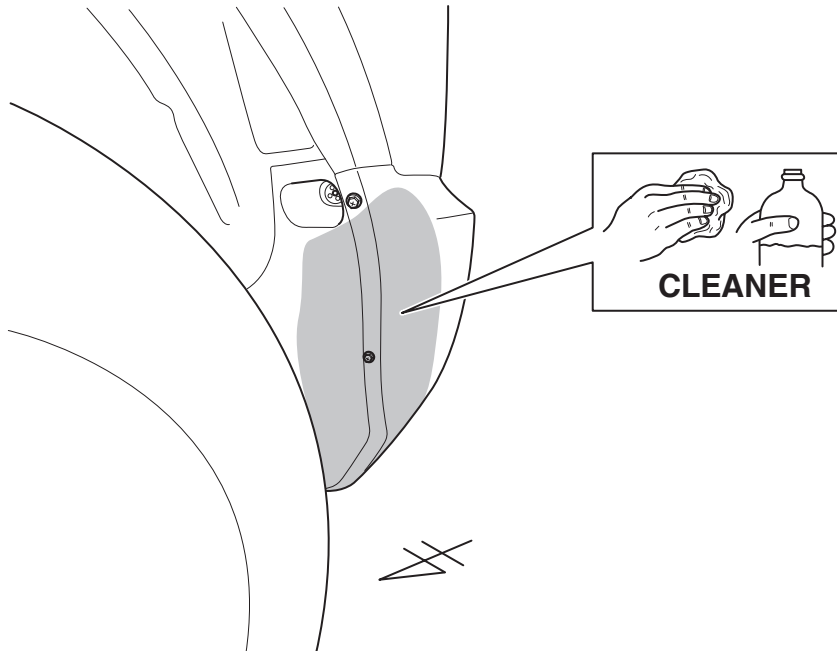

6

L+R

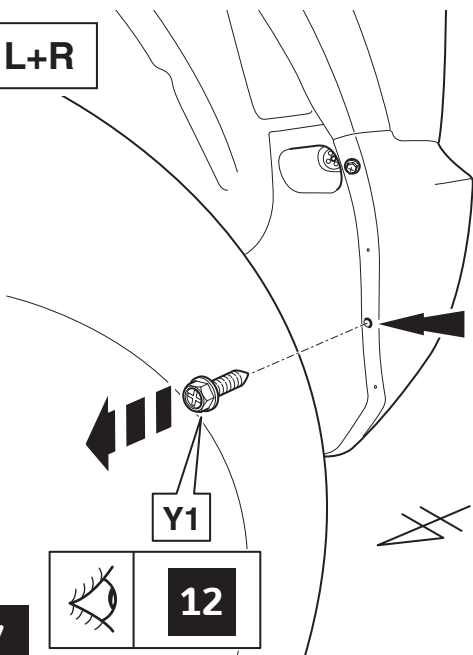
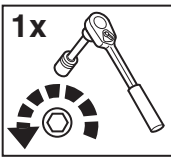

7

L+R

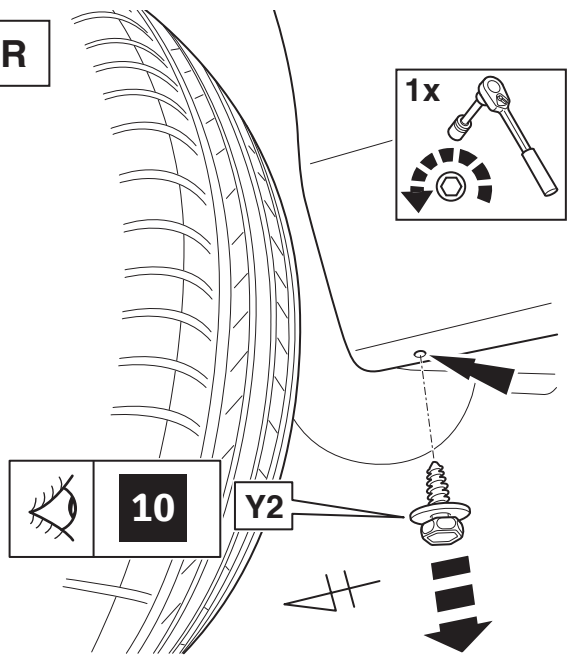
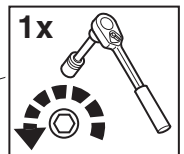

8

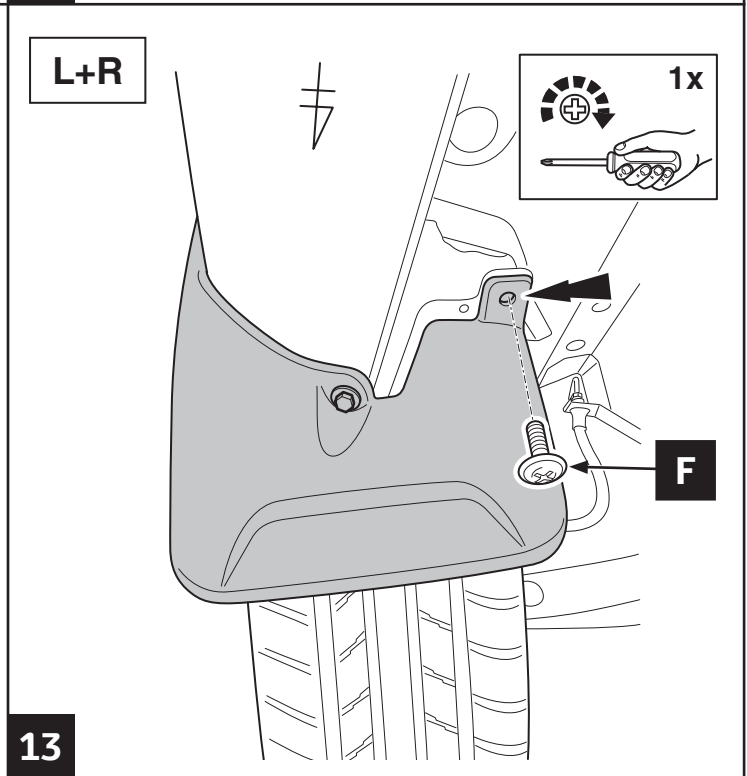
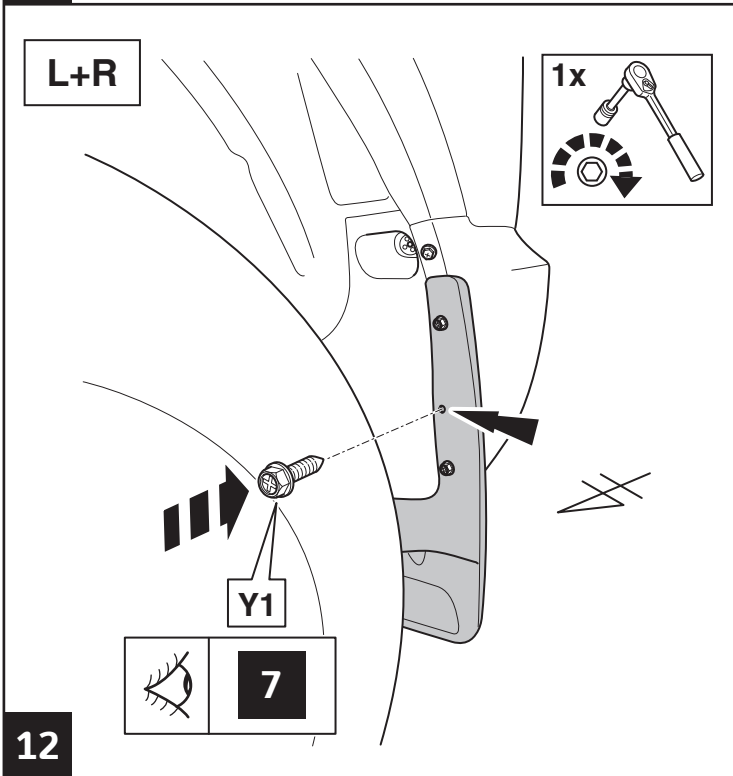
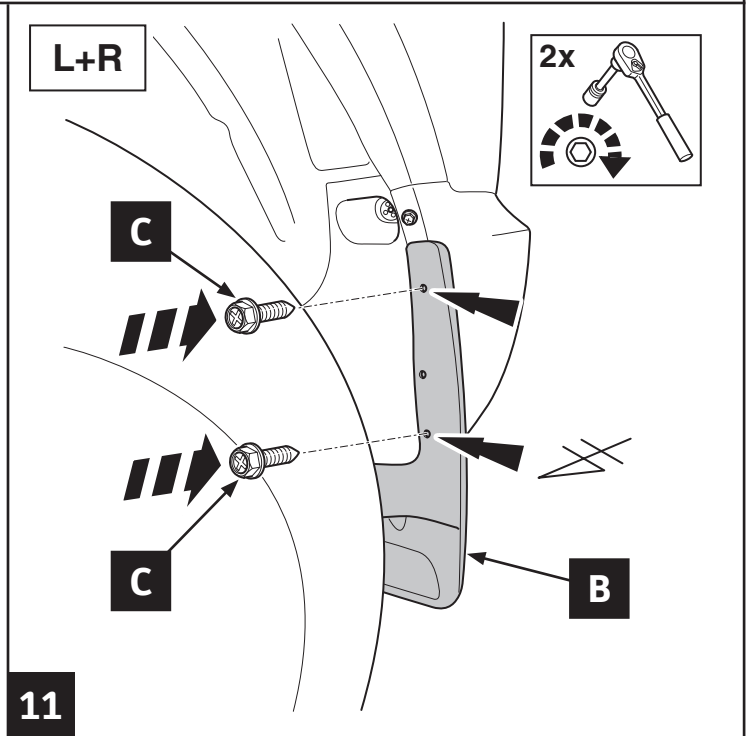
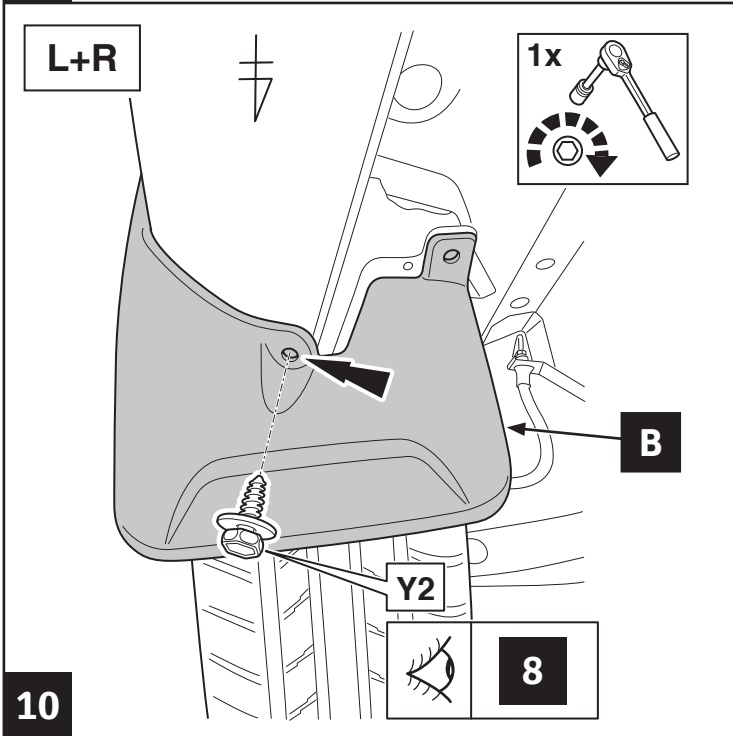
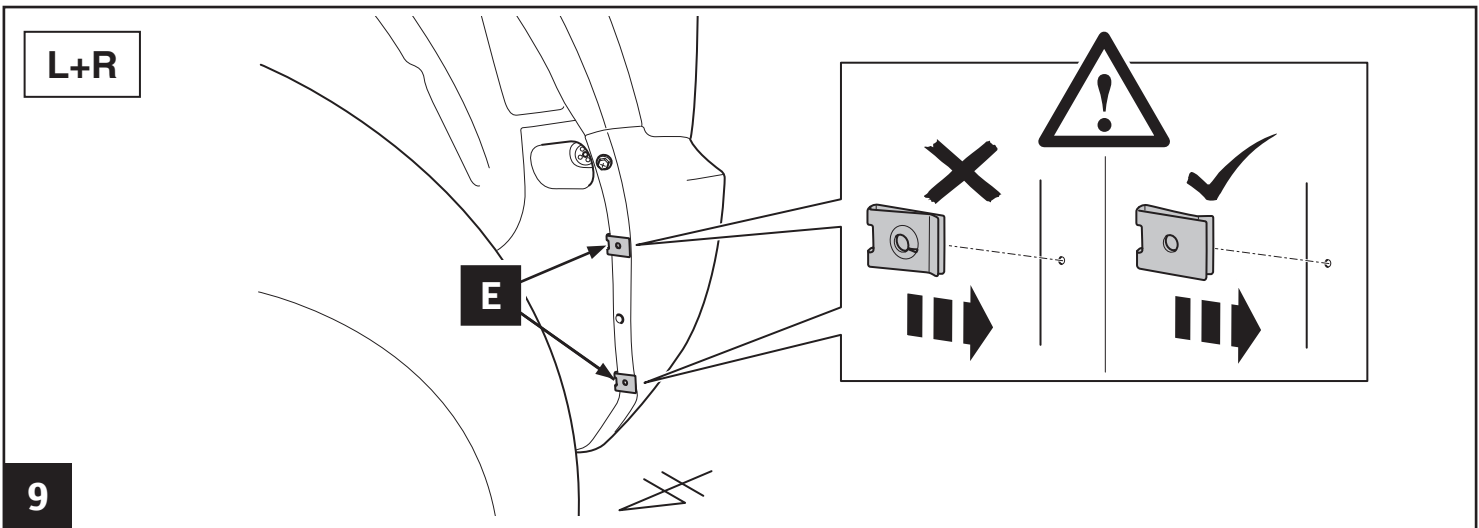

CHECK SHEET



TOYOTA

ALWAYS A BETTER WAY

Model / Year **RAV4 2012/12**

Mud Flaps - Front & Rear

VIN n°

P/N = OK

LH = RH

LH = RH

= OK

Installation Date:

... / ... / ...

Technician Name & Signature:

Stamp: