



Urban Cruiser

Rear Bumper Protection Plate
Installation instructions



Model year: 01/2009

Vehicle code: N*P11**-AHF**W

Part number: PZ415-B4521-00

 Weight: 0.35 kg

Manual reference number: AIM 001 490-0

Revision Record

Rev. No	Date	Page	Picture	Update	New	Deleted Steps

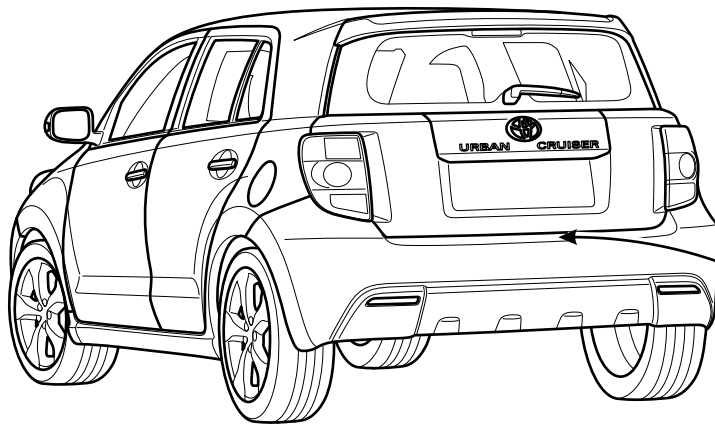

PZ415-B4521-00

A



Spiess Hecker Sontora

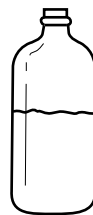

Sikkens M600
Spiess Hecker 7799
Hydro cleaner PZ469-A0002-50

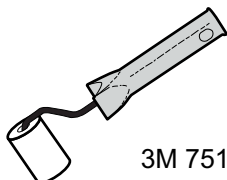
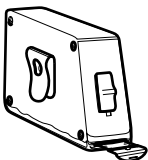

3M 751



SOAP
SEIFE

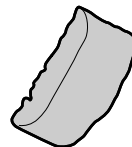

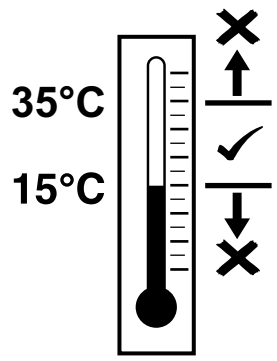

1

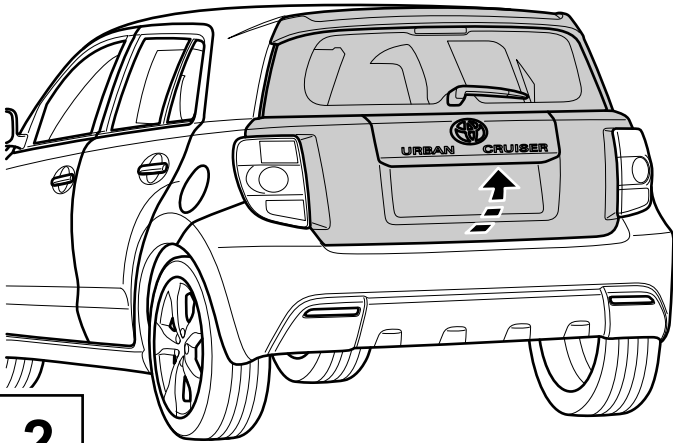

2

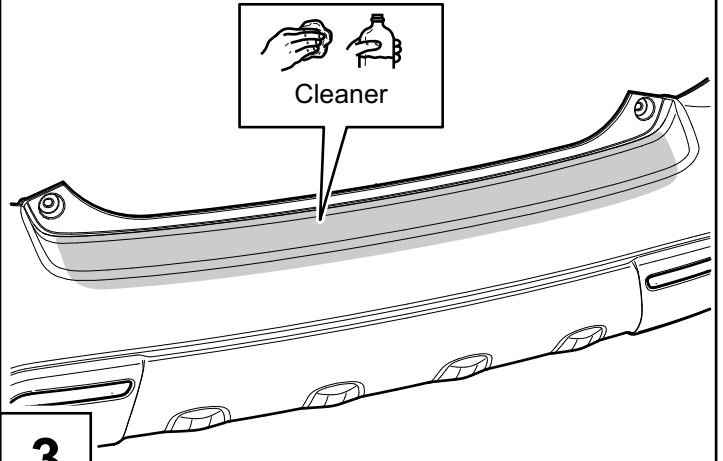

3

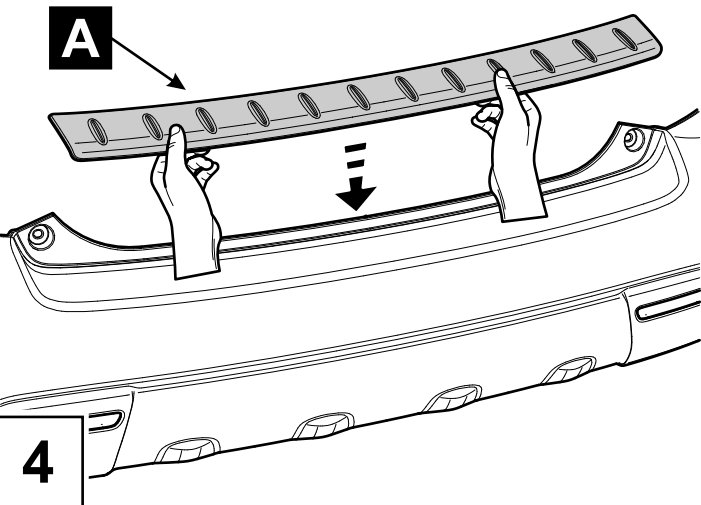

4

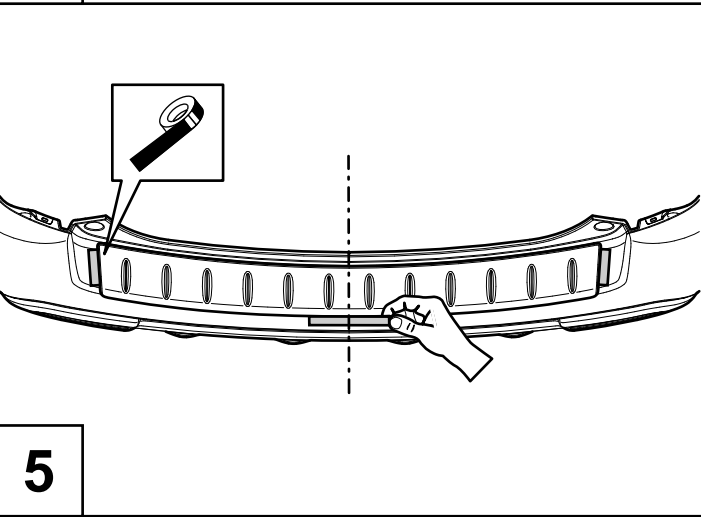
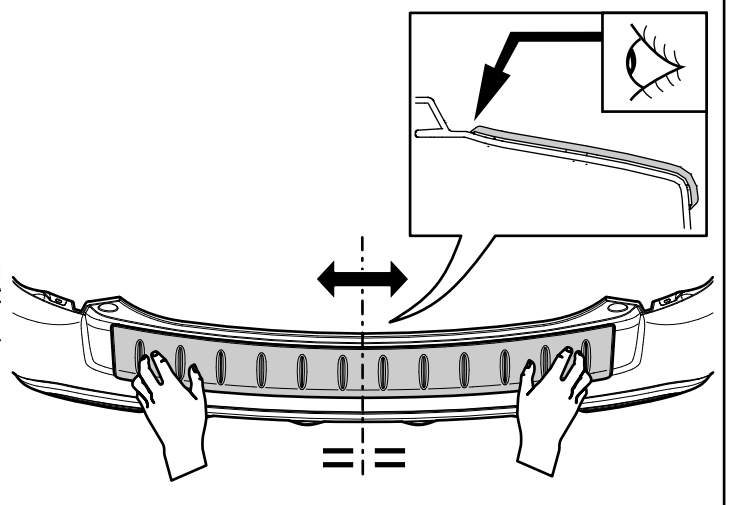

5

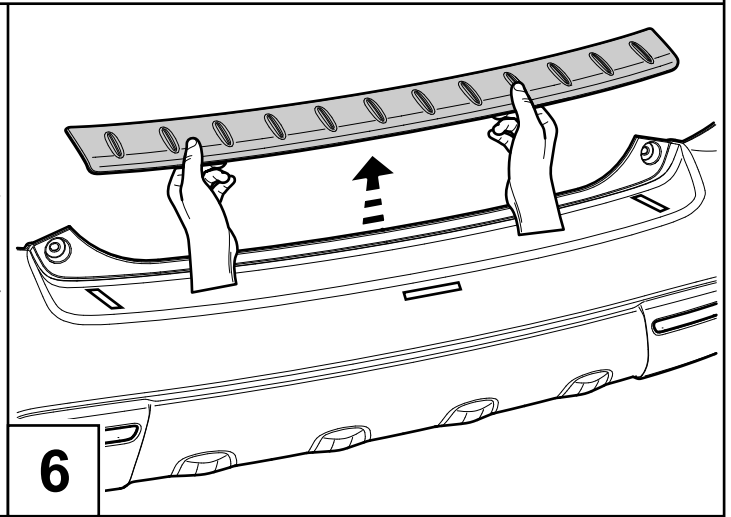

6

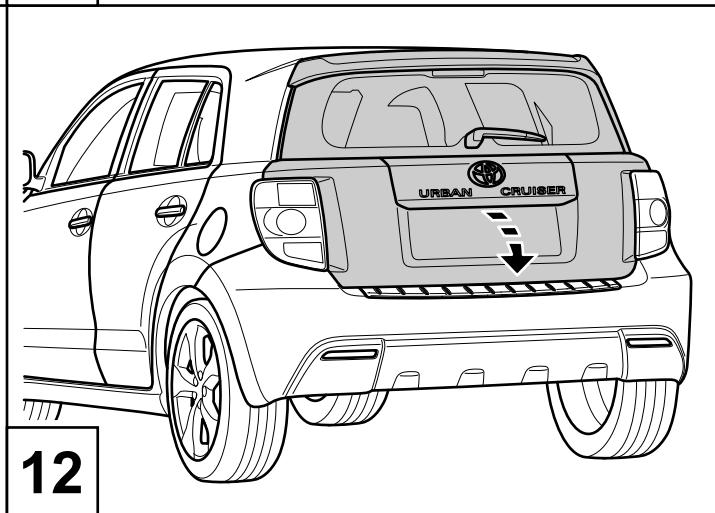
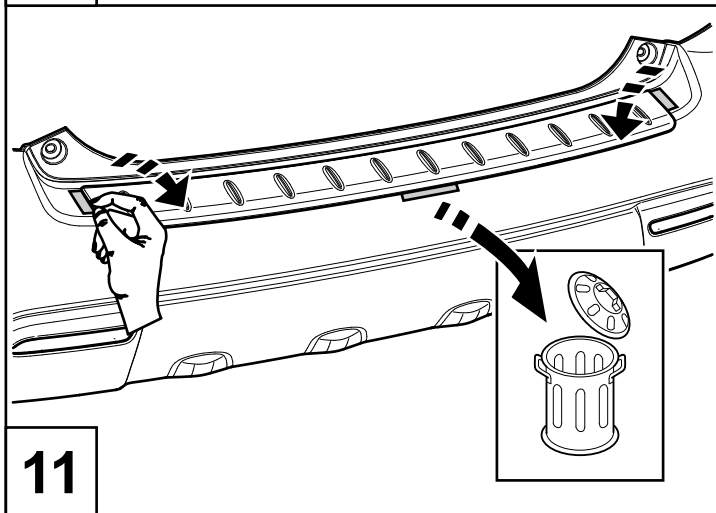
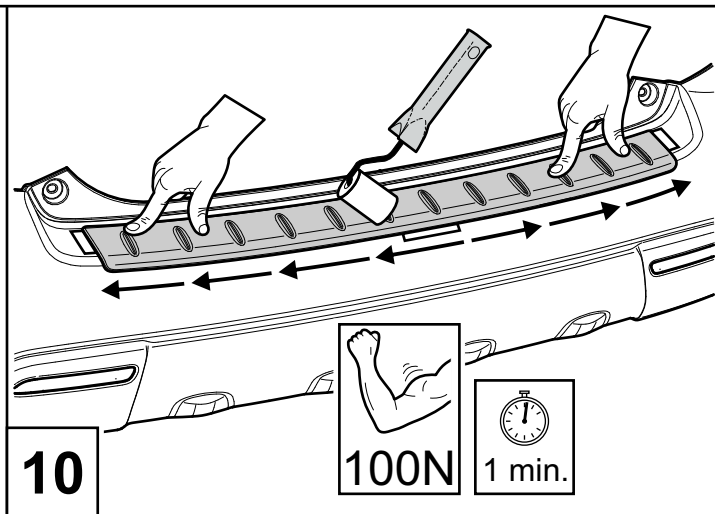
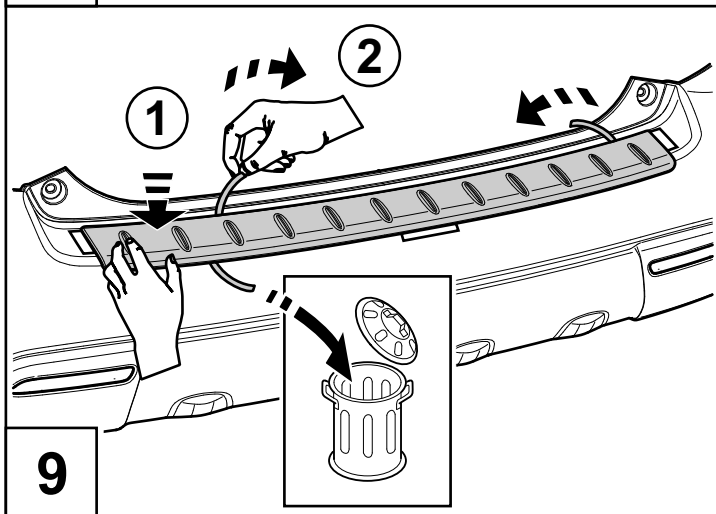
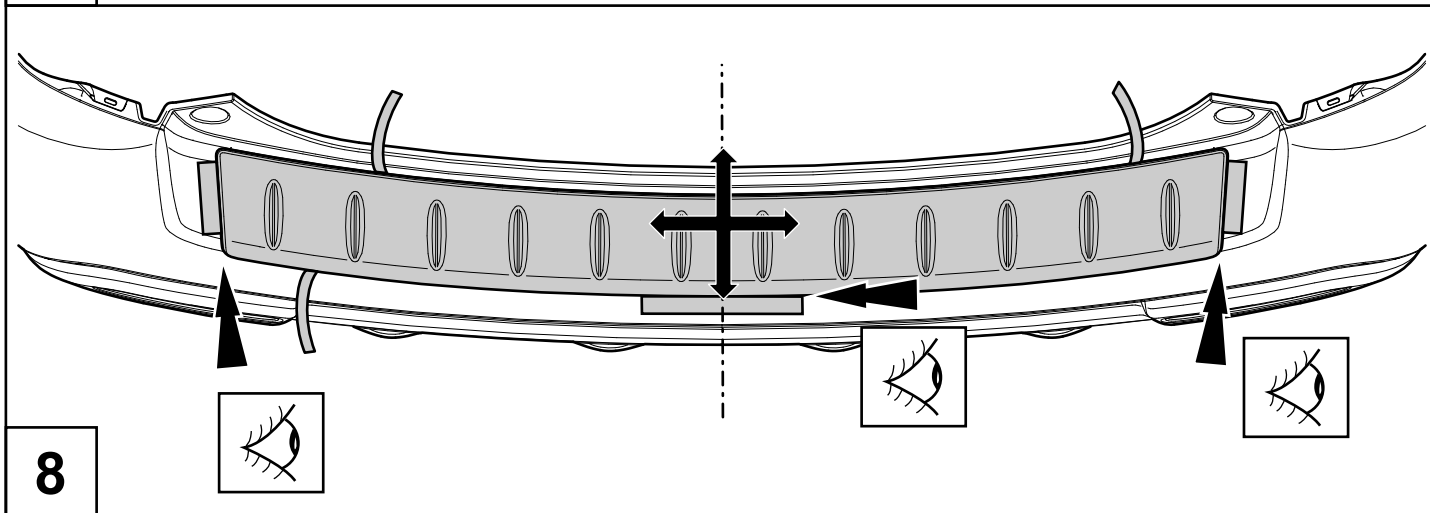
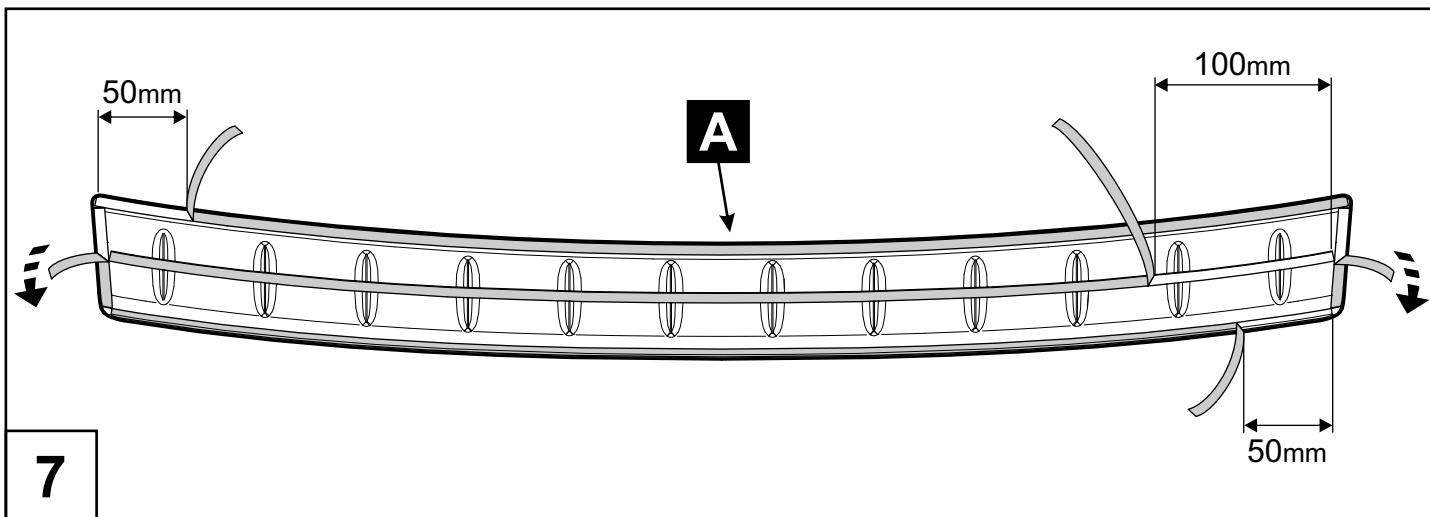

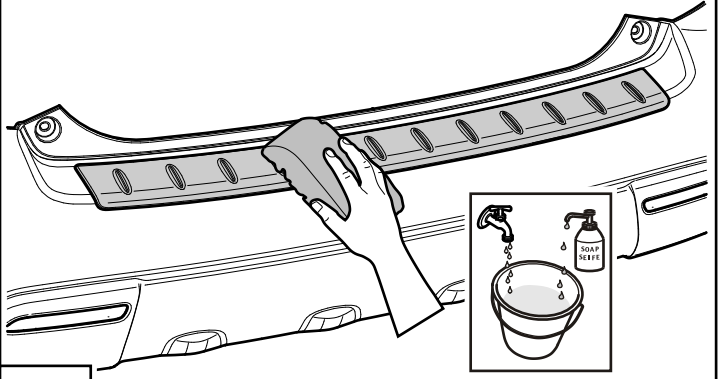
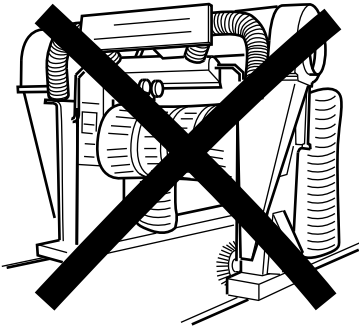

13



14