



TOYOTA

ALWAYS A
BETTER WAY

Auris

Mudflaps

Installation Instructions

Model year: 2012/10
Vehicle code: **E18**-DH***W
Part number: 53008-02010

Manual reference number: AIM 002 666-0

Revision record

Rev. No.	Date	Page	Picture	Update	New	Deleted steps

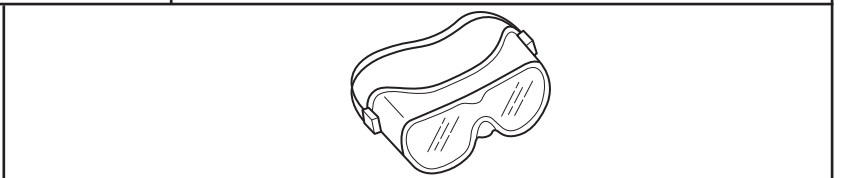
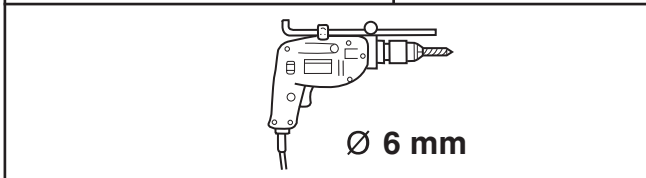
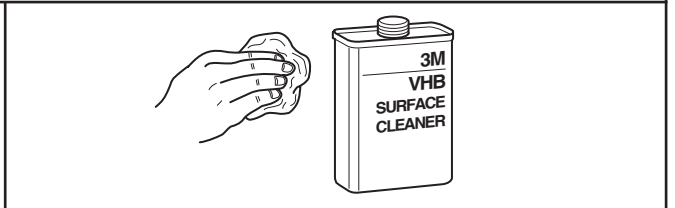
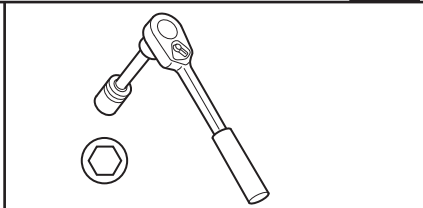
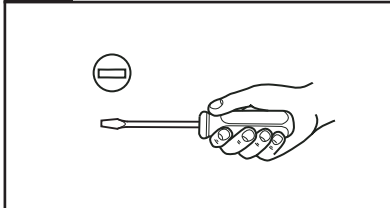
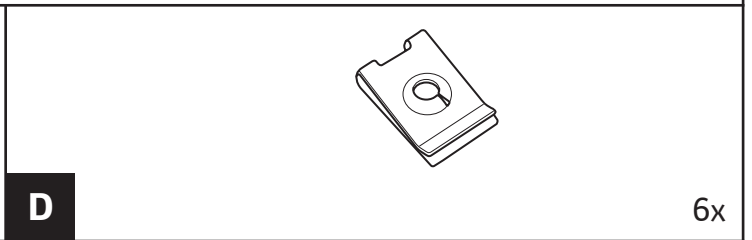
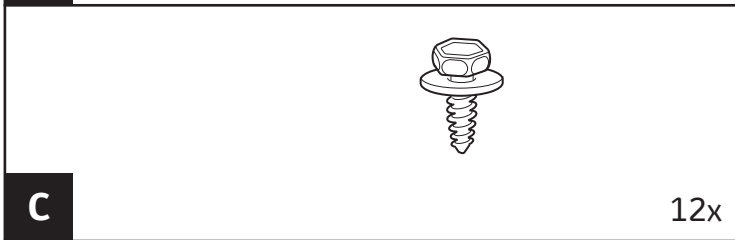
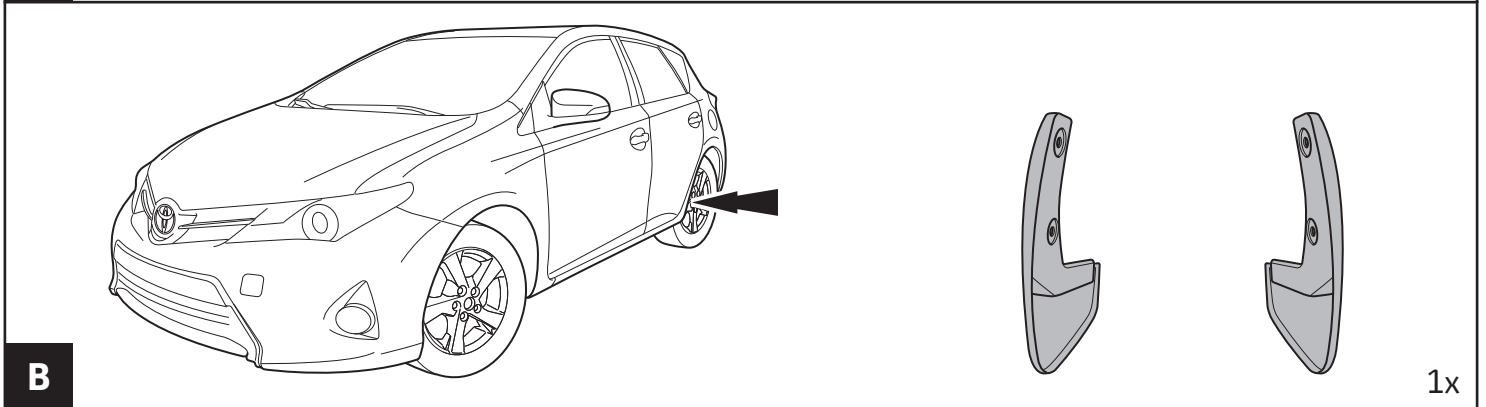
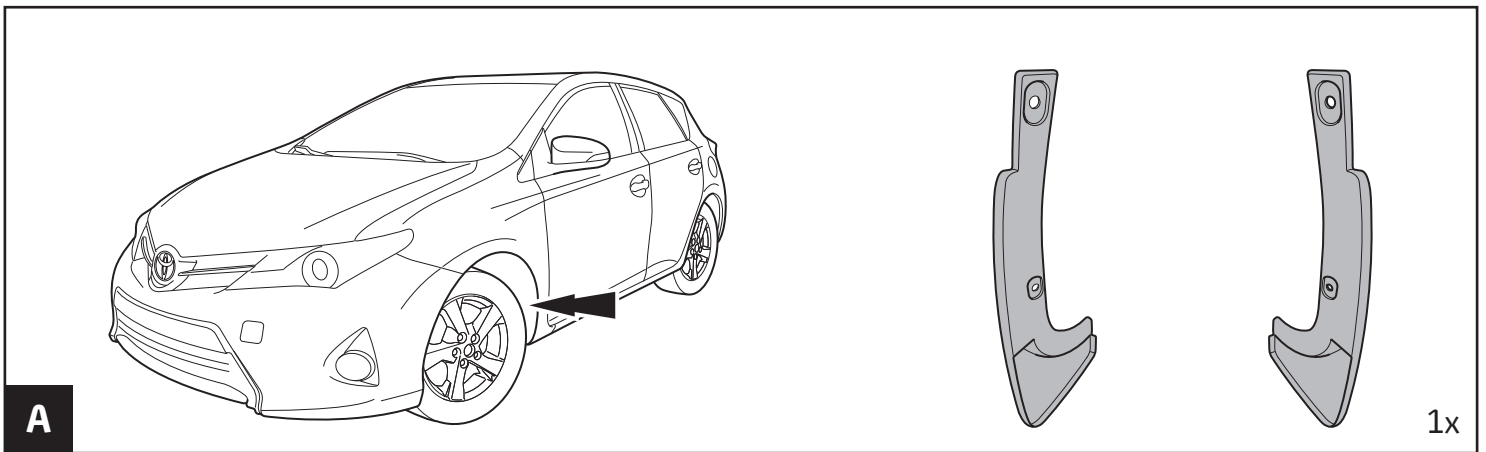

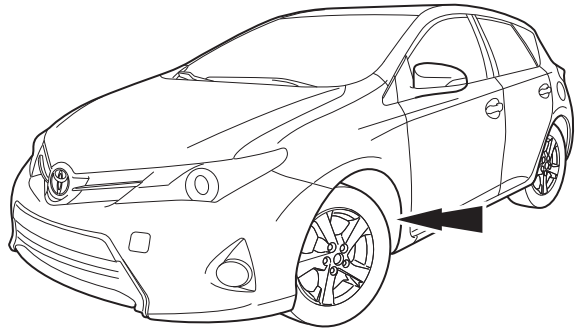
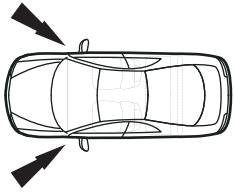

1

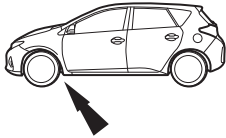
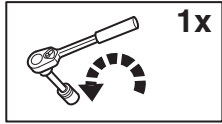

L+R

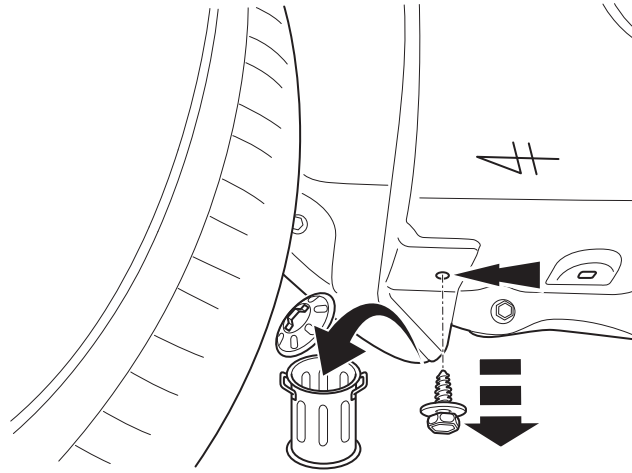

2

L+R

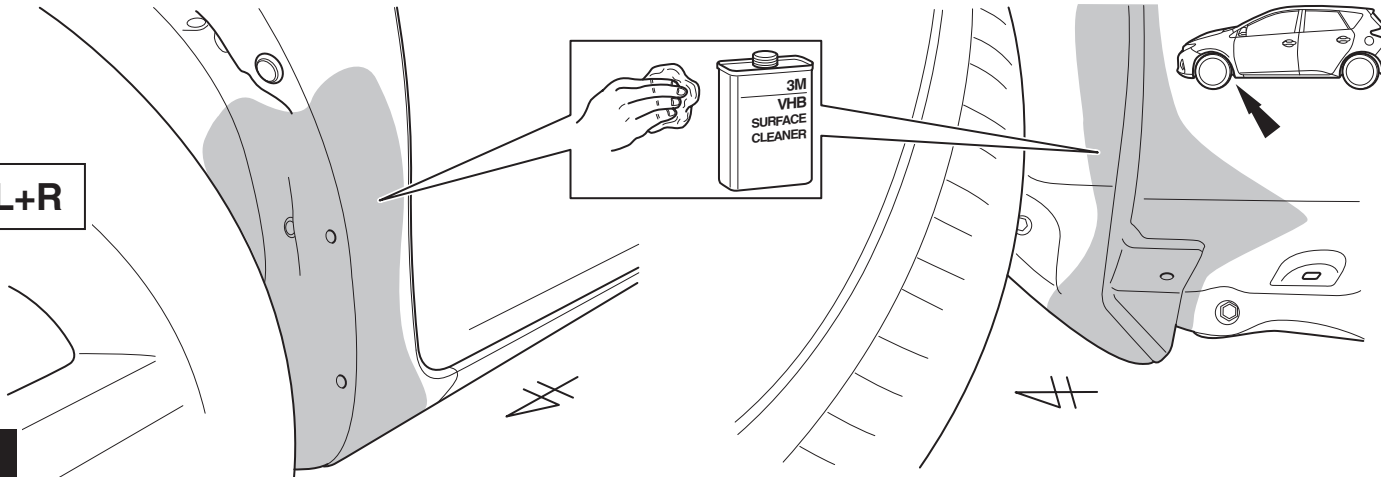
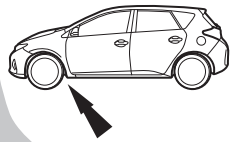
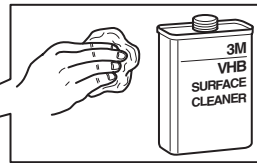

3

L+R

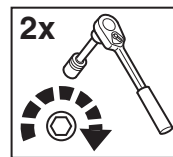
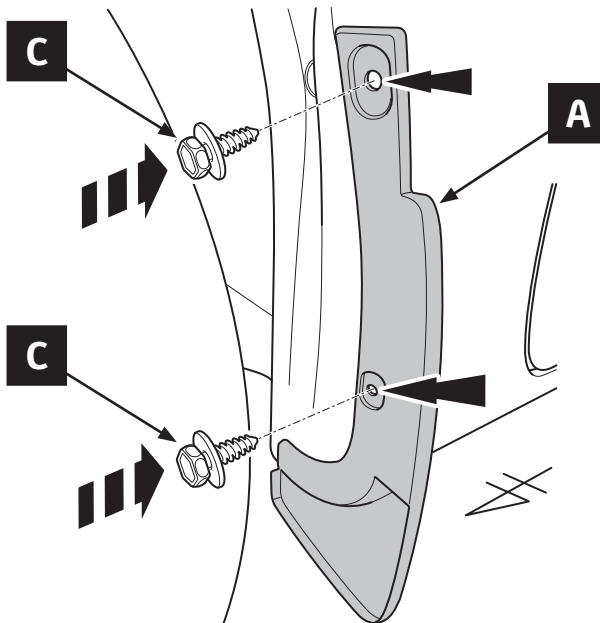

4

L+R

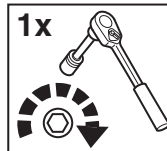

A

C

5

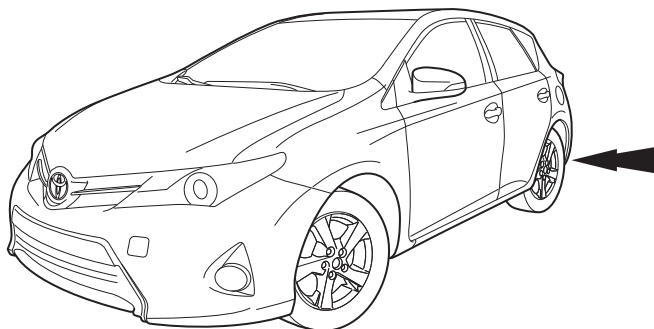
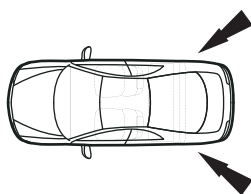

6

L+R

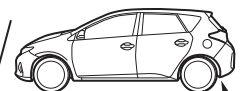

7

L+R

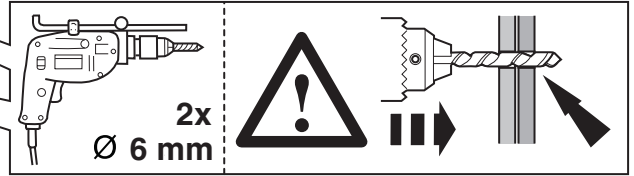
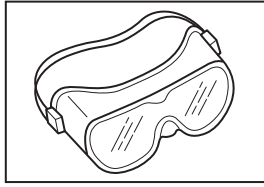

8

L+R

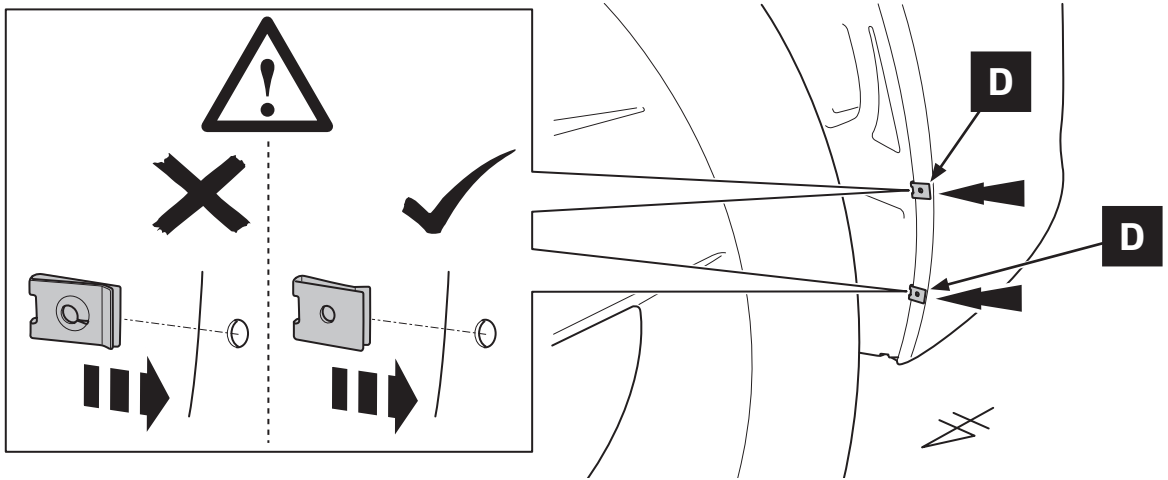

9

L+R

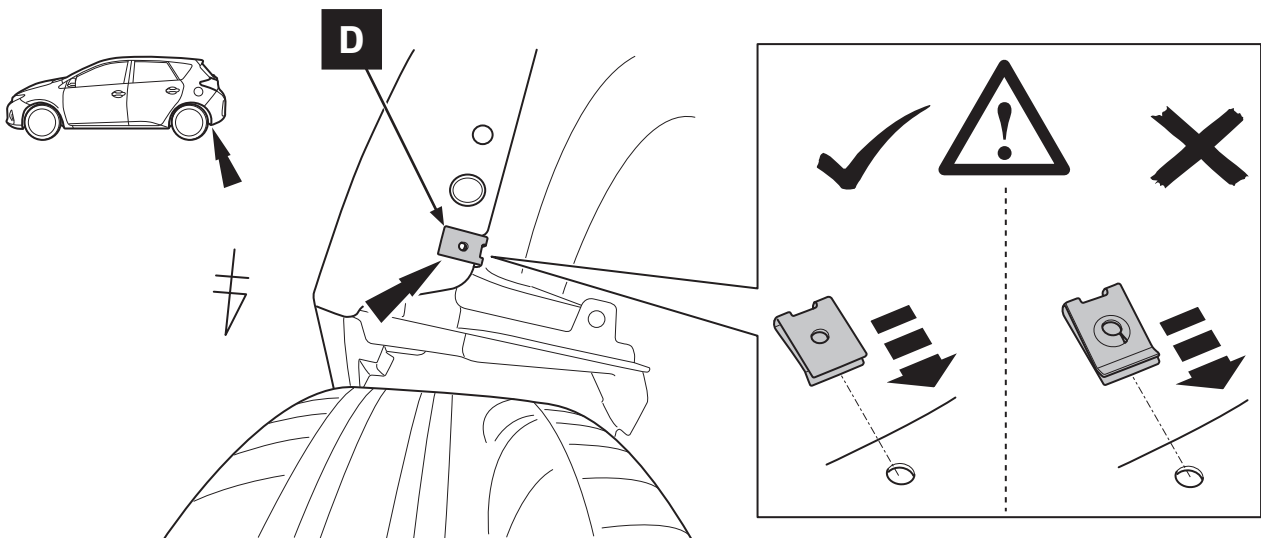

10

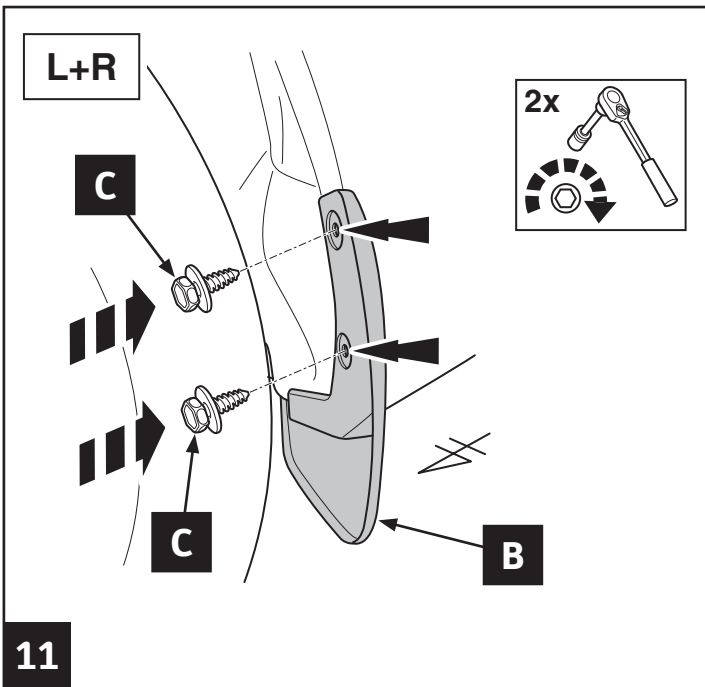

11

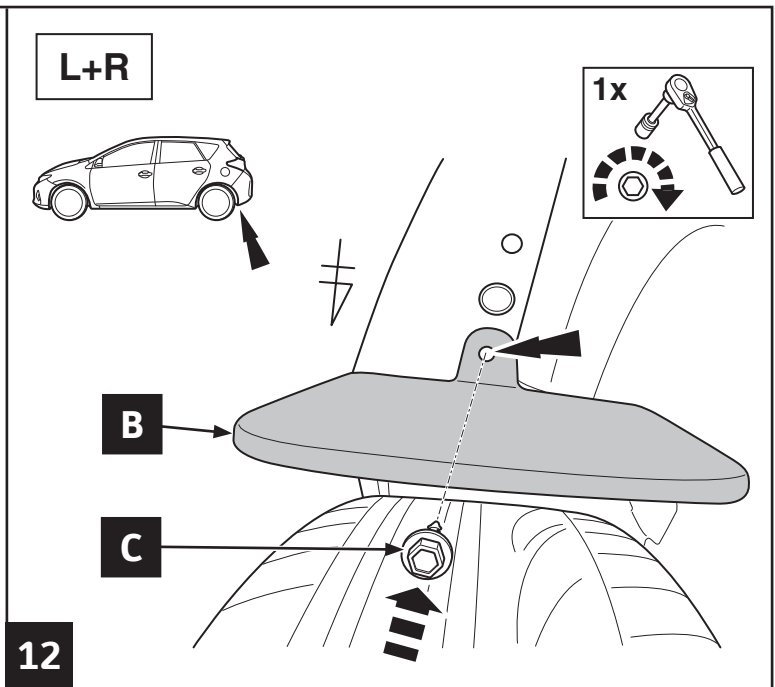

12

CHECK SHEET



TOYOTA

Model / Year **Auris 2012/10**

Mud Flaps - Front & Rear

VIN n°

ALWAYS A BETTER WAY

P/N = OK

LH = RH

LH = RH

= OK

Installation Date:

... / ... /

Technician Name & Signature:

Stamp: