



Urban Cruiser

Rear Bumper Protection Plate Stylish

Installation Instructions

Model year: 01/2009
Vehicle code: N*P11**-AHF**W
Part number: PZ402-B4520-00

 Weight: 0.8 kg

Manual reference number: AIM 001 554 -2

Revision Record

Rev. No	Date	Page	Picture	Update	New	Deleted Steps
1	11.05.2009			several updates		
2	22.07.2009	3	Kit		Part B	
2	22.07.2009	6	11, 12, 14		X	
2	22.07.2009	7			X	

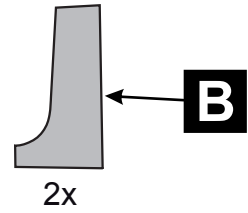
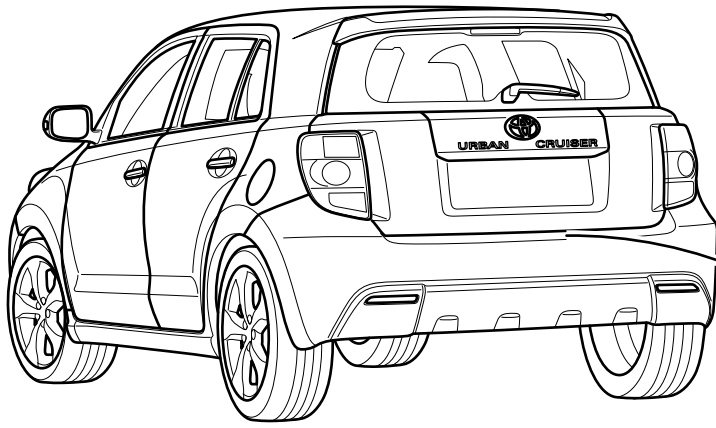

PZ402-B4520-00 **A**

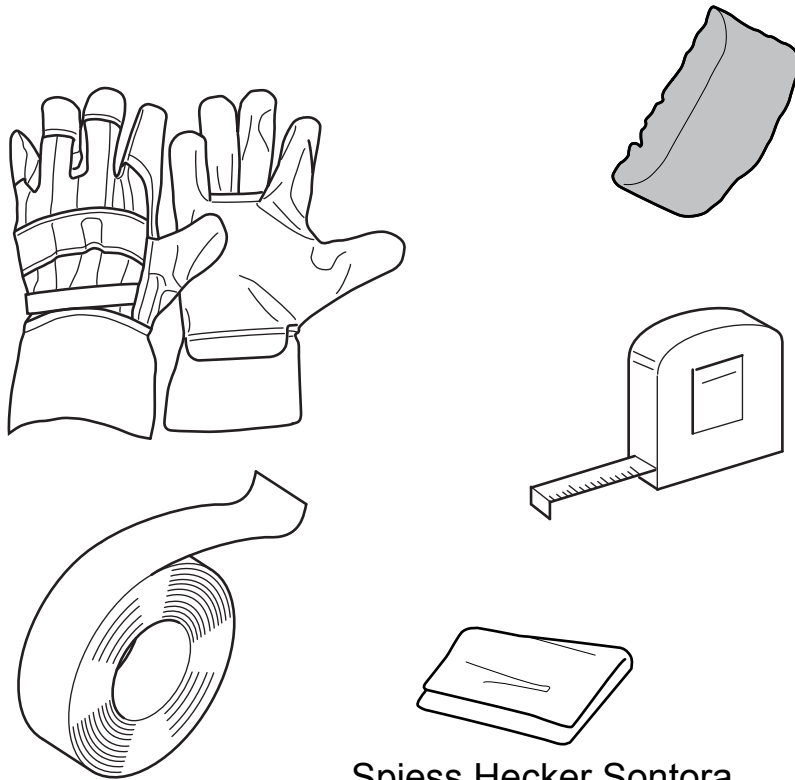
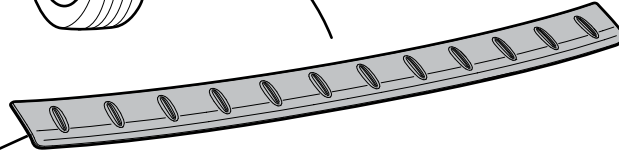

Spiess Hecker Sontora

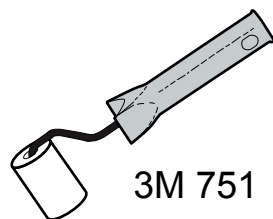
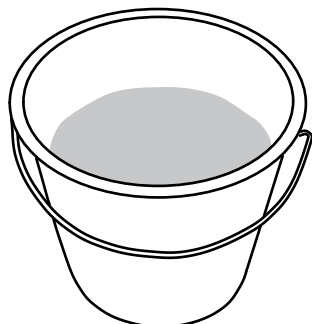

3M 751



Sikkens M600

Spiess Hecker 7799

Panel degreaser
PZ469-CL001-50

35°C

15°C



1

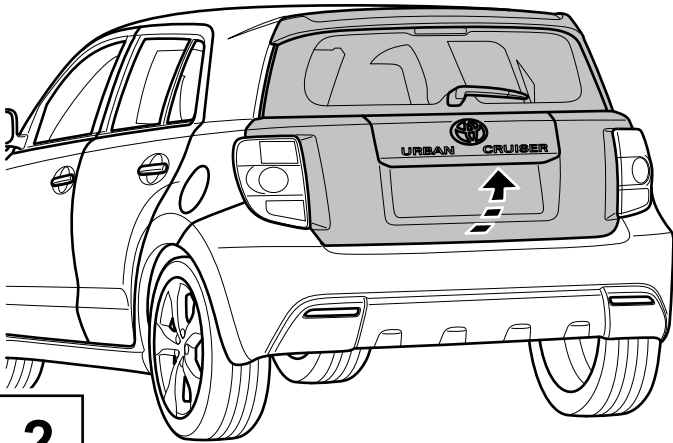

2

Spiess Hecker
Sontora

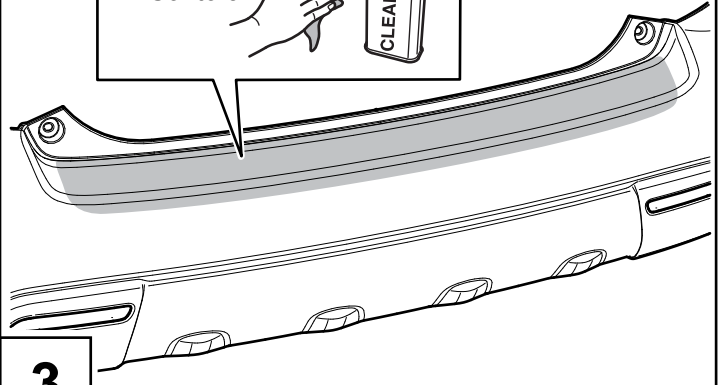

3

A

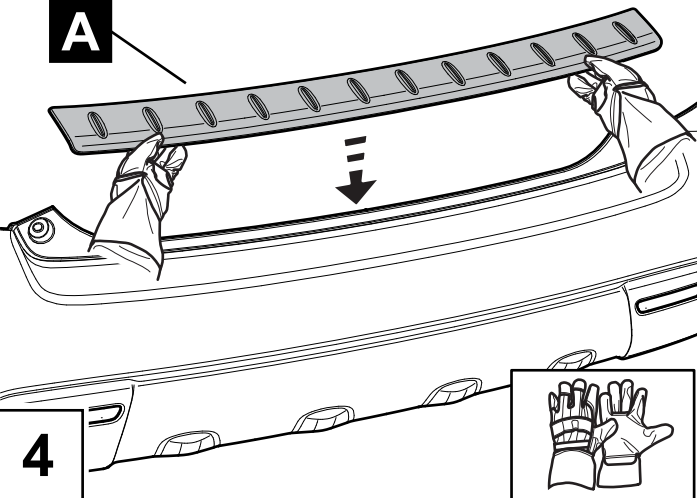

4

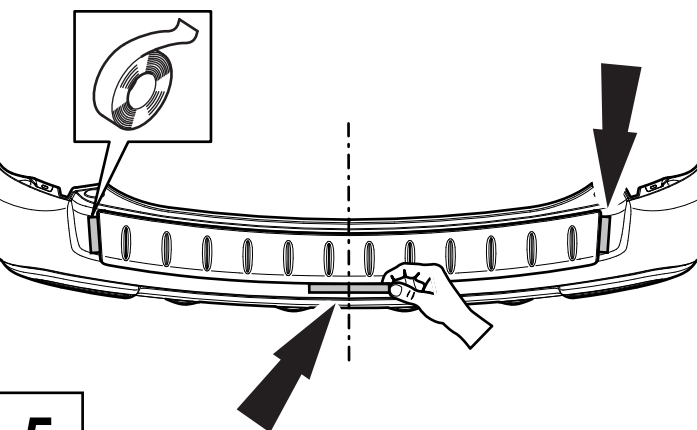
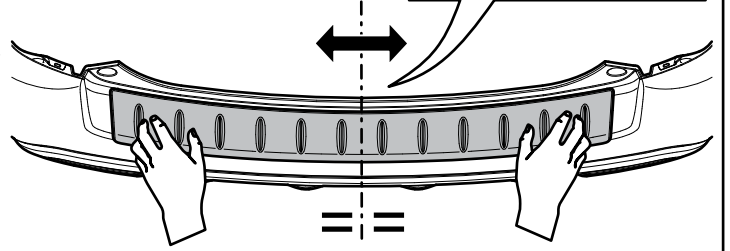
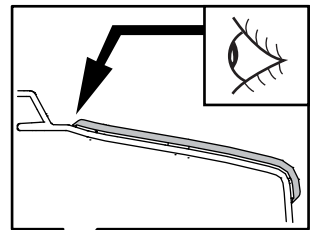

5

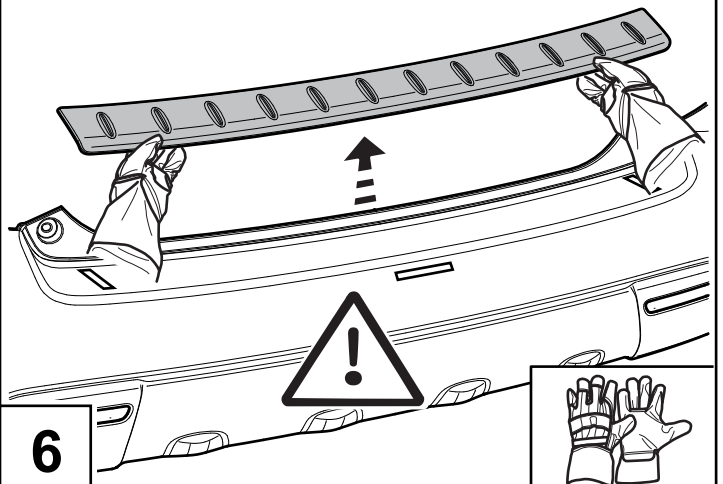

6

Spiess Hecker
Sontora

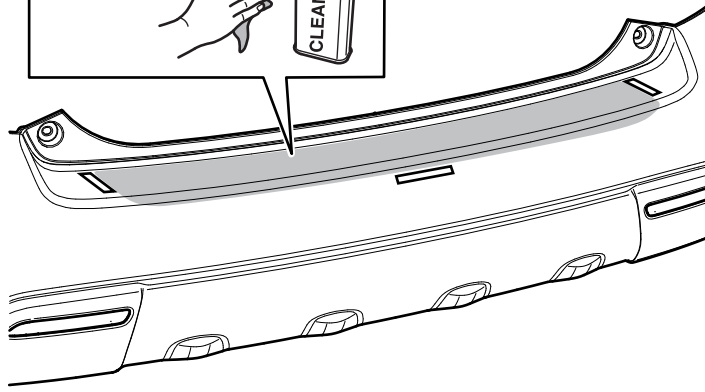

7

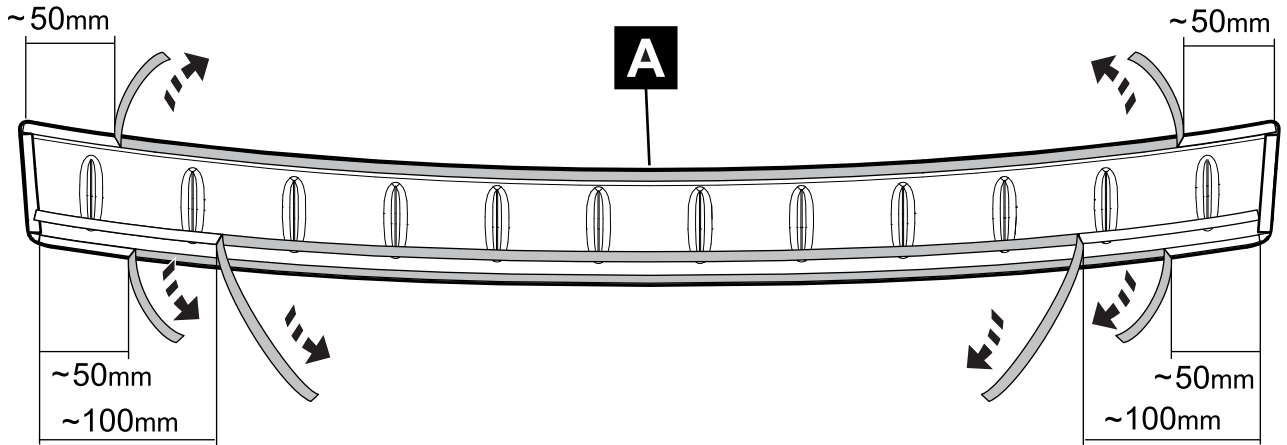

8

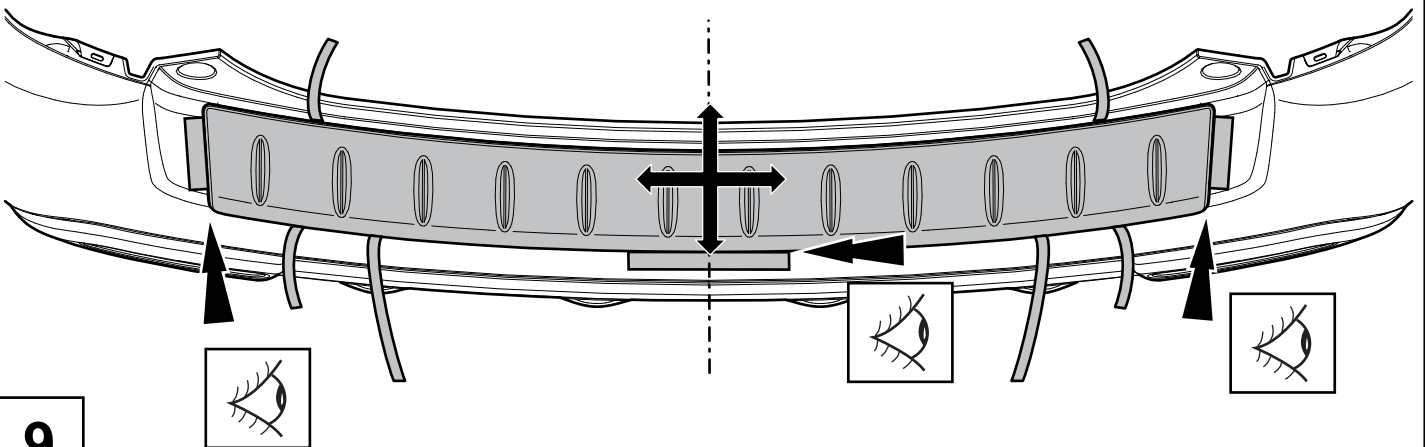

9

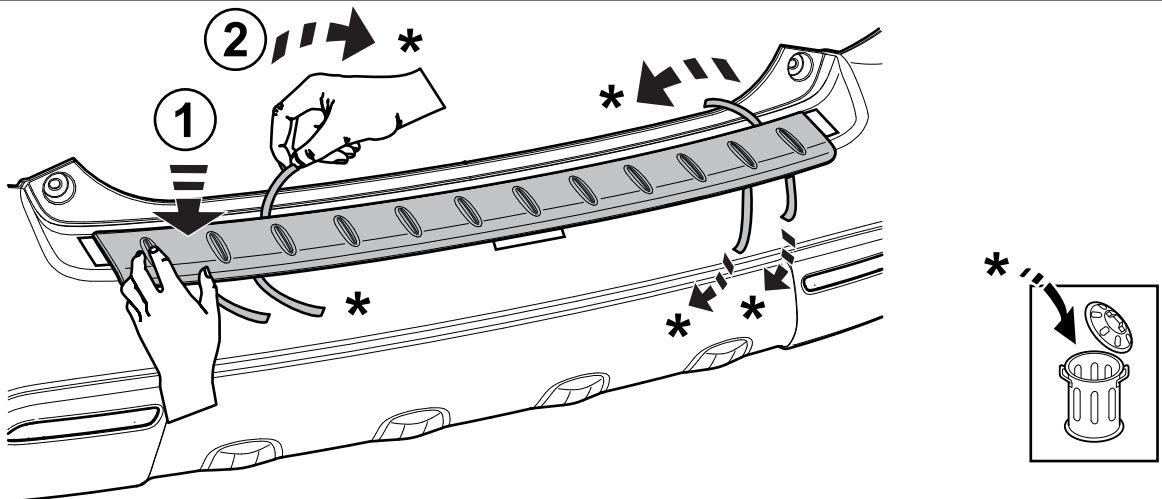

10

