



**TOYOTA**

ALWAYS A  
**BETTER WAY**

# Rav4

## Rear Lamp Chrome Bezel

Installation Instructions

Model year: 2012/12  
Vehicle code: \*\*A4\*\*-AN\*\*\*W  
Part number: PZD38-0R005

Manual reference number: AIM 002 784-0

# Revision record

Rev. No.	Date	Page	Picture	Update	New	Deleted steps

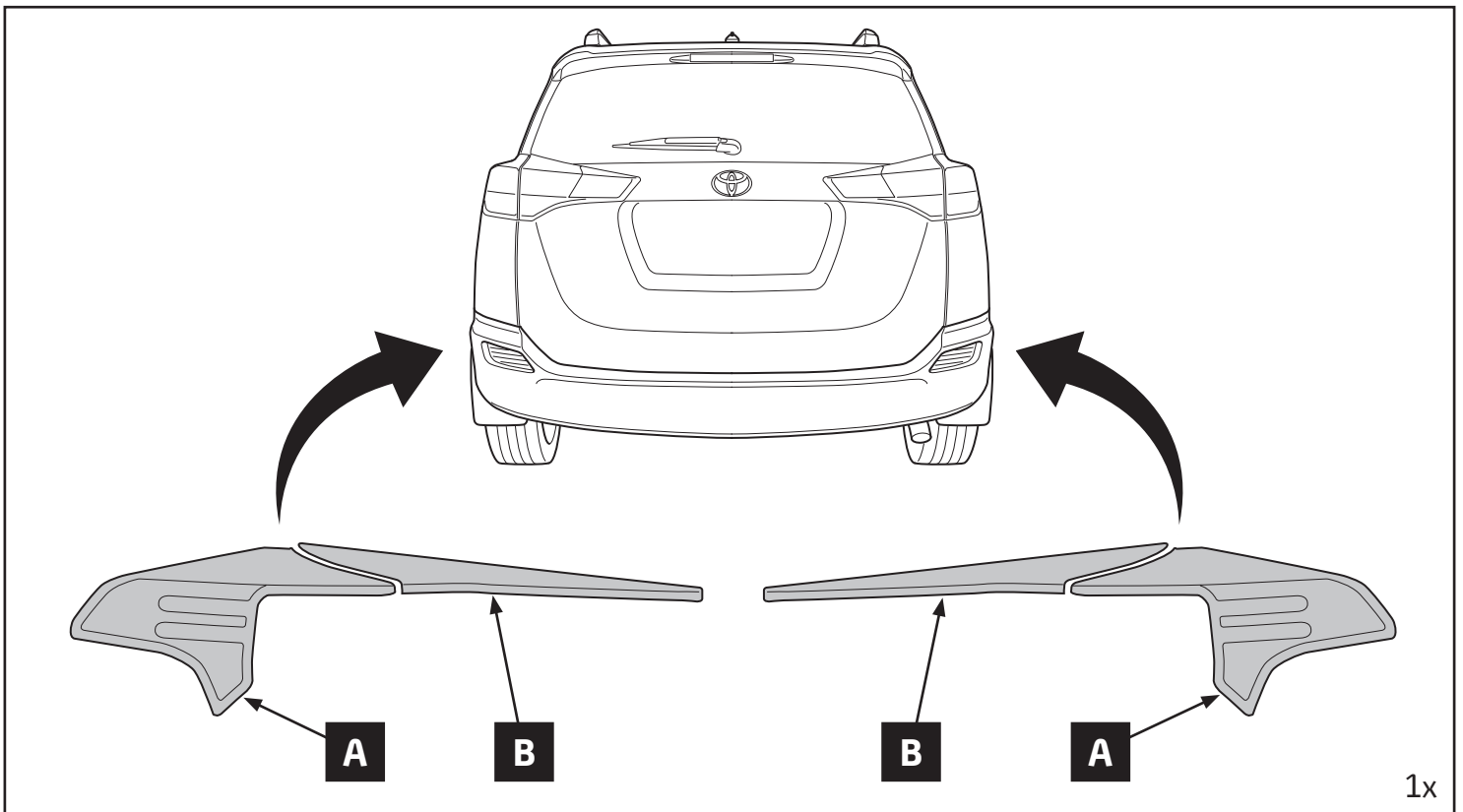

	<p>PZ415-00000-00</p> <p><b>3M adhesion promoter 4298 UV</b></p>	<p><b>3M VHB SURFACE CLEANER</b></p>
	<p><b>Spieß Hecker Sontora 3M 2010</b></p>	

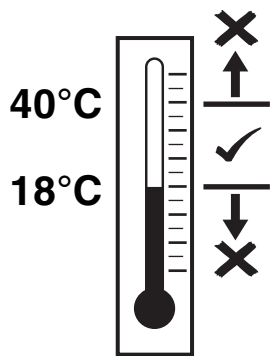

0-95%

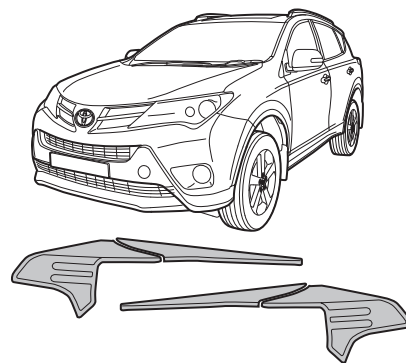

1

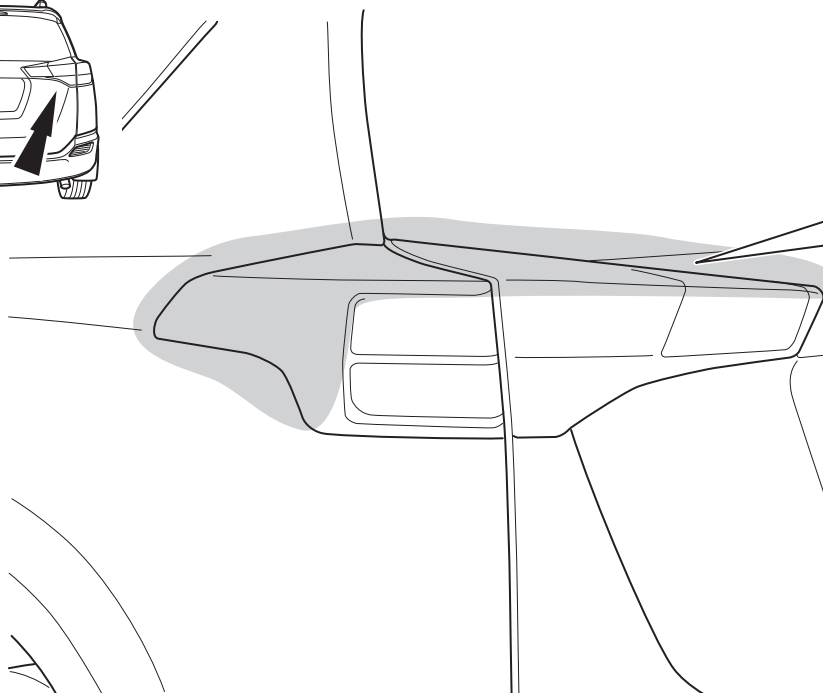
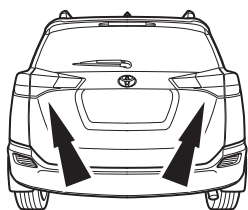

1		
2		3M adhesive promoter 4298 UV
3		> 1.5 min. < 1 h.

2

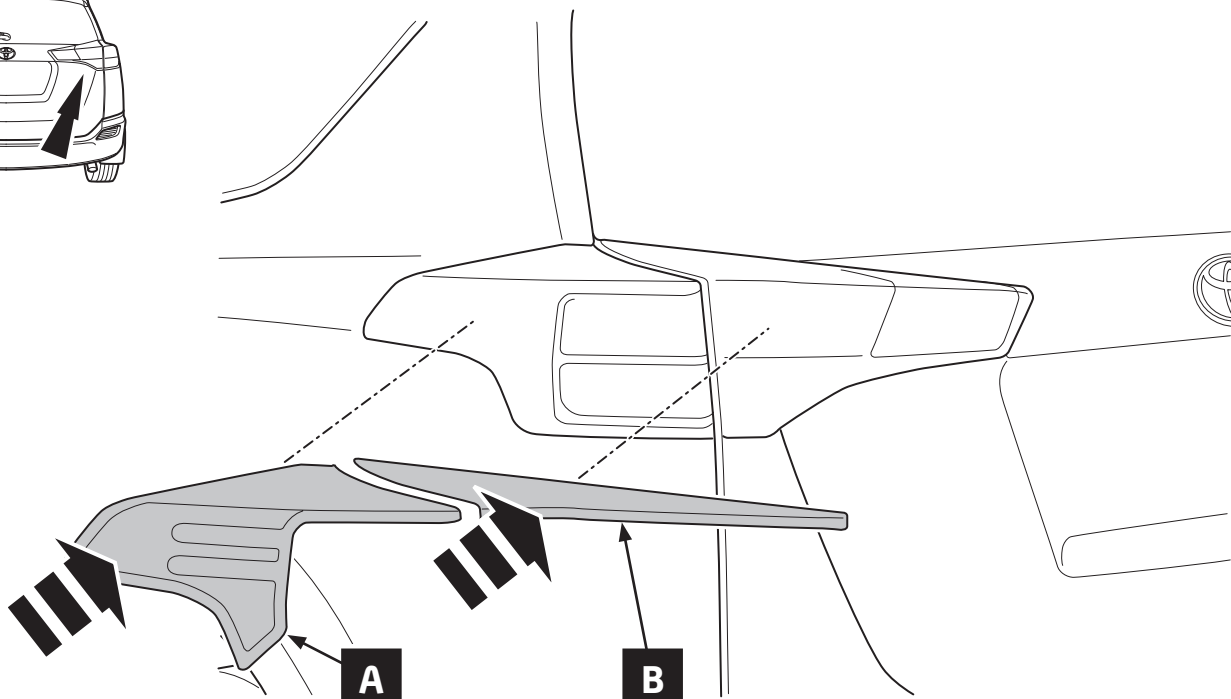
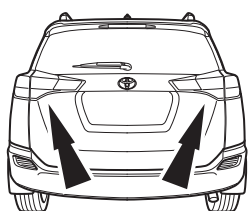

3

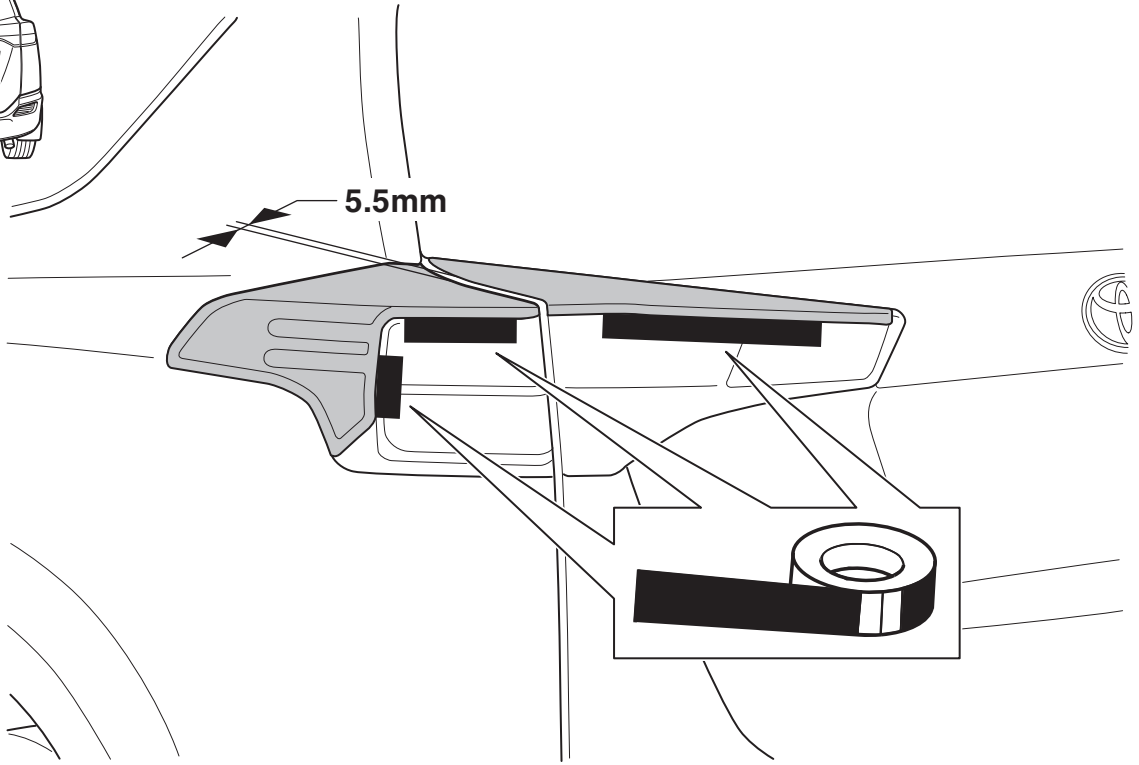
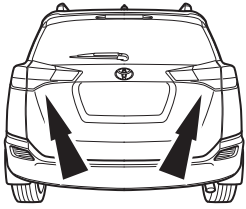

4

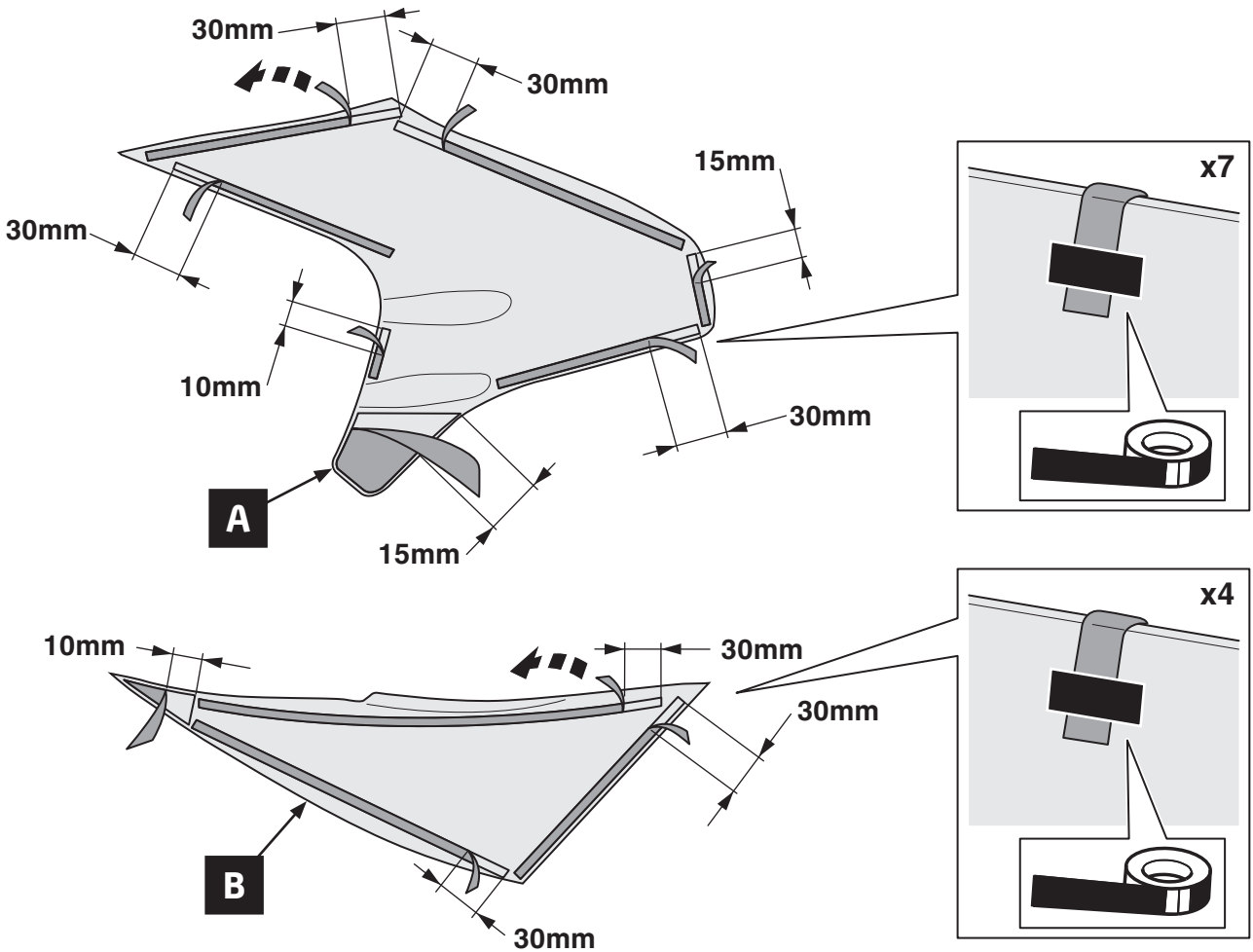

5

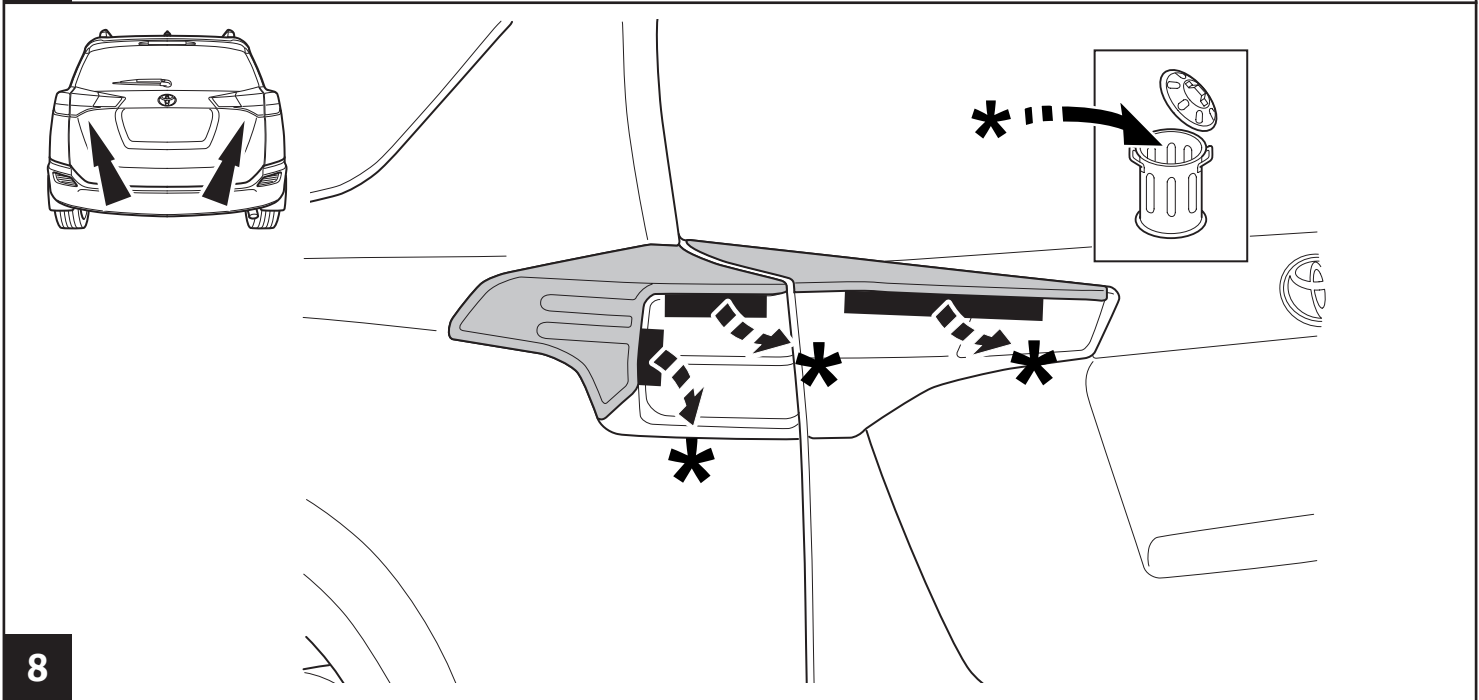
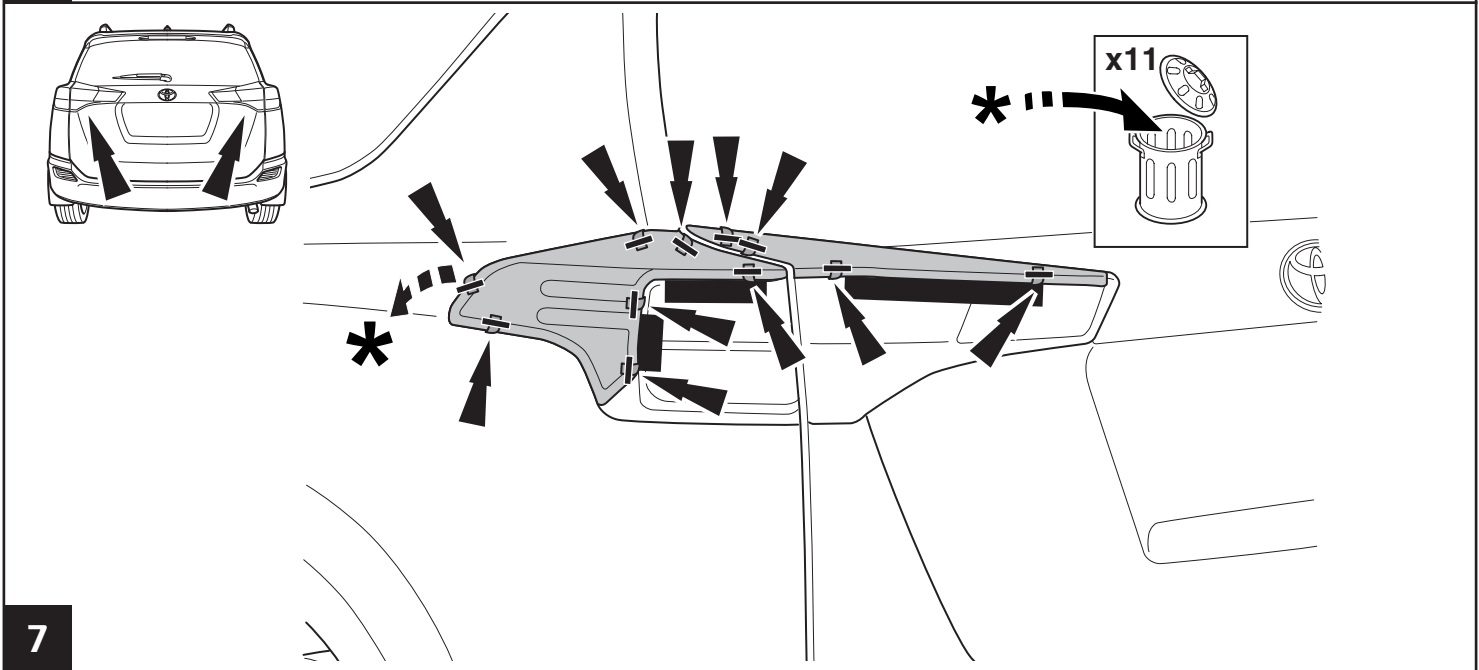
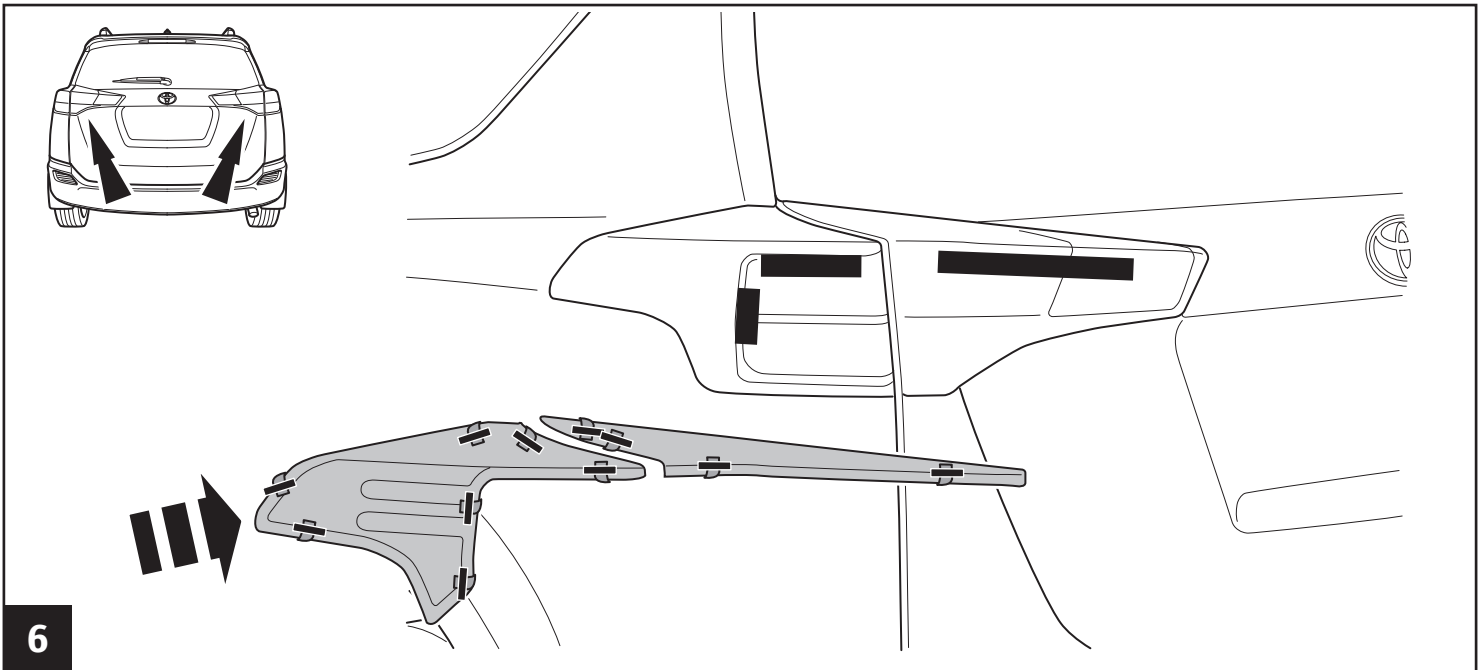

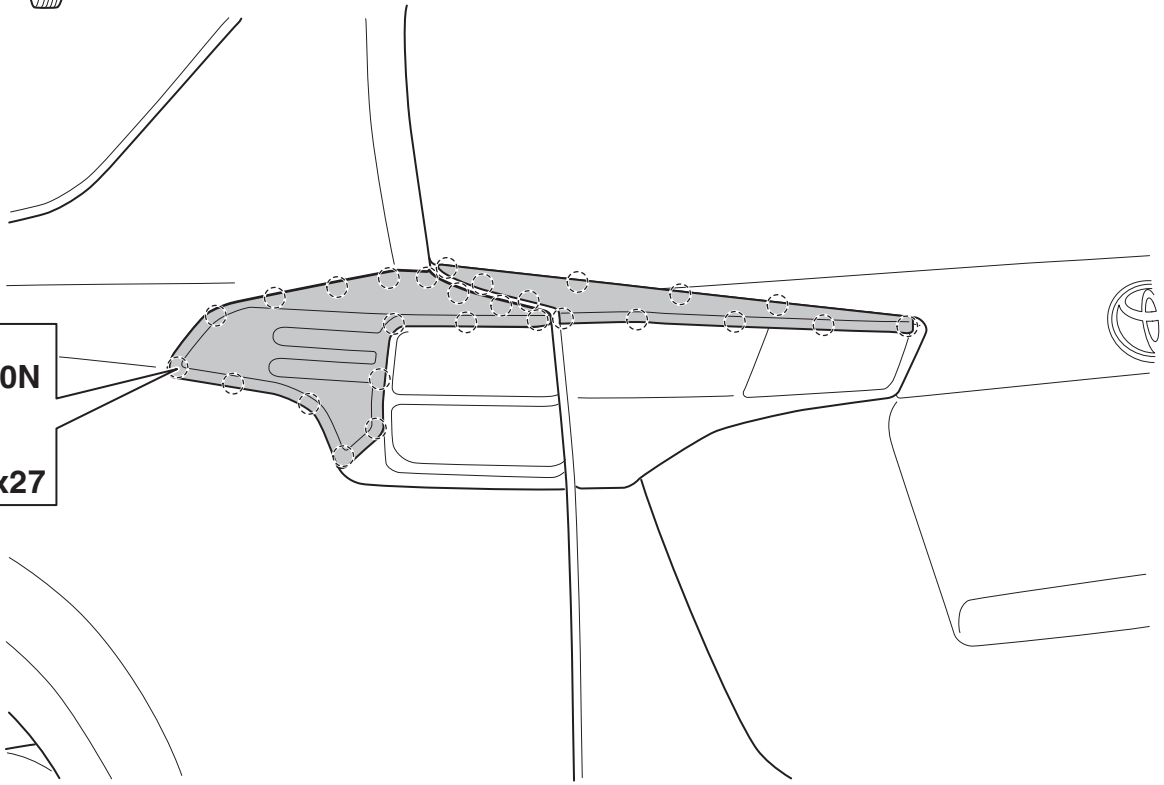
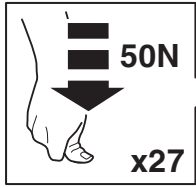
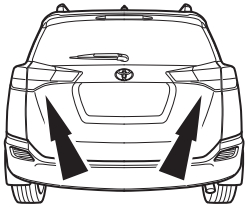

9

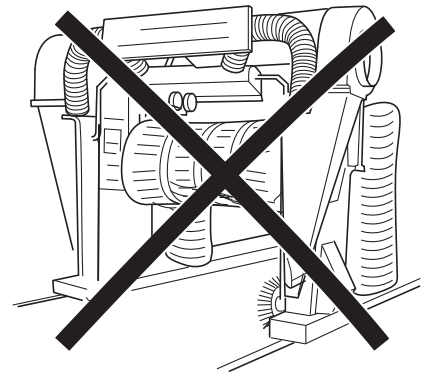
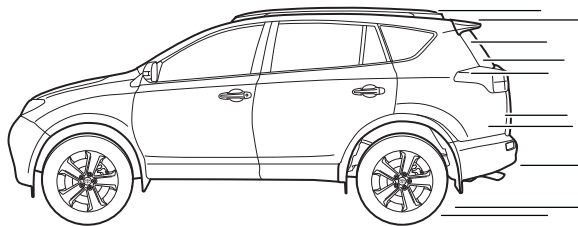
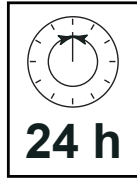
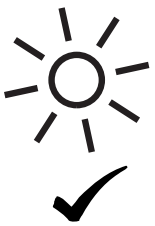

10

# CHECK SHEET



**TOYOTA**

Model / Year **RAV4 2012/12**



**Rear Lamp  
Chrome Bezel**

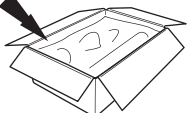

VIN n°

ALWAYS A  
BETTER WAY

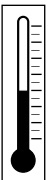
 **P/N = OK**





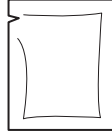

40°C    
18°C 

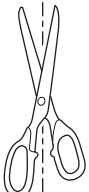

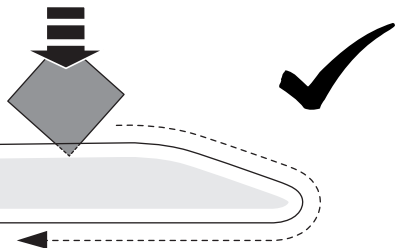
   
 **CLEANER**

   
**3M adhesion promoter  
4298 UV**

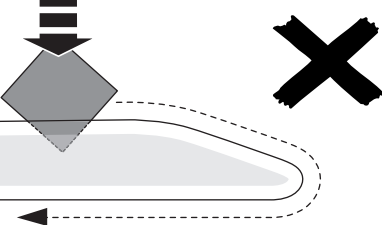

  **= OK**

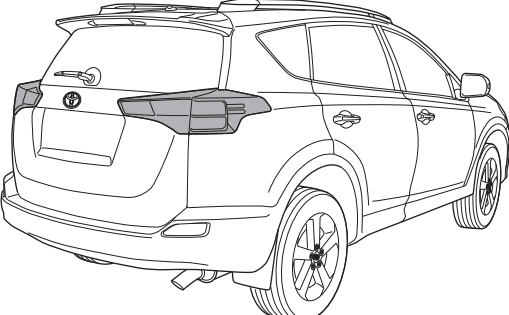

**Installation Date:**

.. / .. / ..

**Technician Name & Signature:**

**Stamp:**